

---

CATÁLOGO

---

**OBISPA.**

CUORE DESIGN

**35** ANOS

# OBISPA.

A vida é repleta de altos e baixos. Invariavelmente, ela nos impõe obstáculos. Por vezes, é preciso encontrar forças, mesmo que tudo pareça incerto.

Mas quando isso acontece, basta lembrar que o sol vai nascer no dia seguinte. E, junto com ele, chega mais uma oportunidade de fazer melhor. Porque somente encarando os desafios percebemos que somos maiores que eles.

Na Obispa, vivemos o presente com intensidade e com a coragem de quem segue sempre em frente. Colocamos nosso coração na produção de cada peça. Porque ele nos faz enxergar além do que os olhos alcançam.

Nascemos na Itália, berço do Renascimento. Um movimento que devolveu o protagonismo ao ser humano suas emoções.

Há 35 anos, a paixão pelo design corre em nossas veias. Por isso, fazemos mais do que produzir acessórios metálicos. Conectamos emoção e tecnologia.

Materializar os desejos daqueles que buscam beleza, sofisticação e qualidade é o que nos move. E o que inspirou o lançamento da coleção Firenze.

Criamos produtos capazes de despertar os sentimentos mais profundos. Cultivamos laços e compartilhamos valores com nossos parceiros. E nos entregamos de corpo e alma em tudo que fazemos.

Independentemente dos desafios que o futuro nos reserva. Seguimos diariamente buscando nosso lugar ao sol guiados pela coragem que vem do coração.

**Obispa Cuore Design**

C U O R E  
D E S I G N

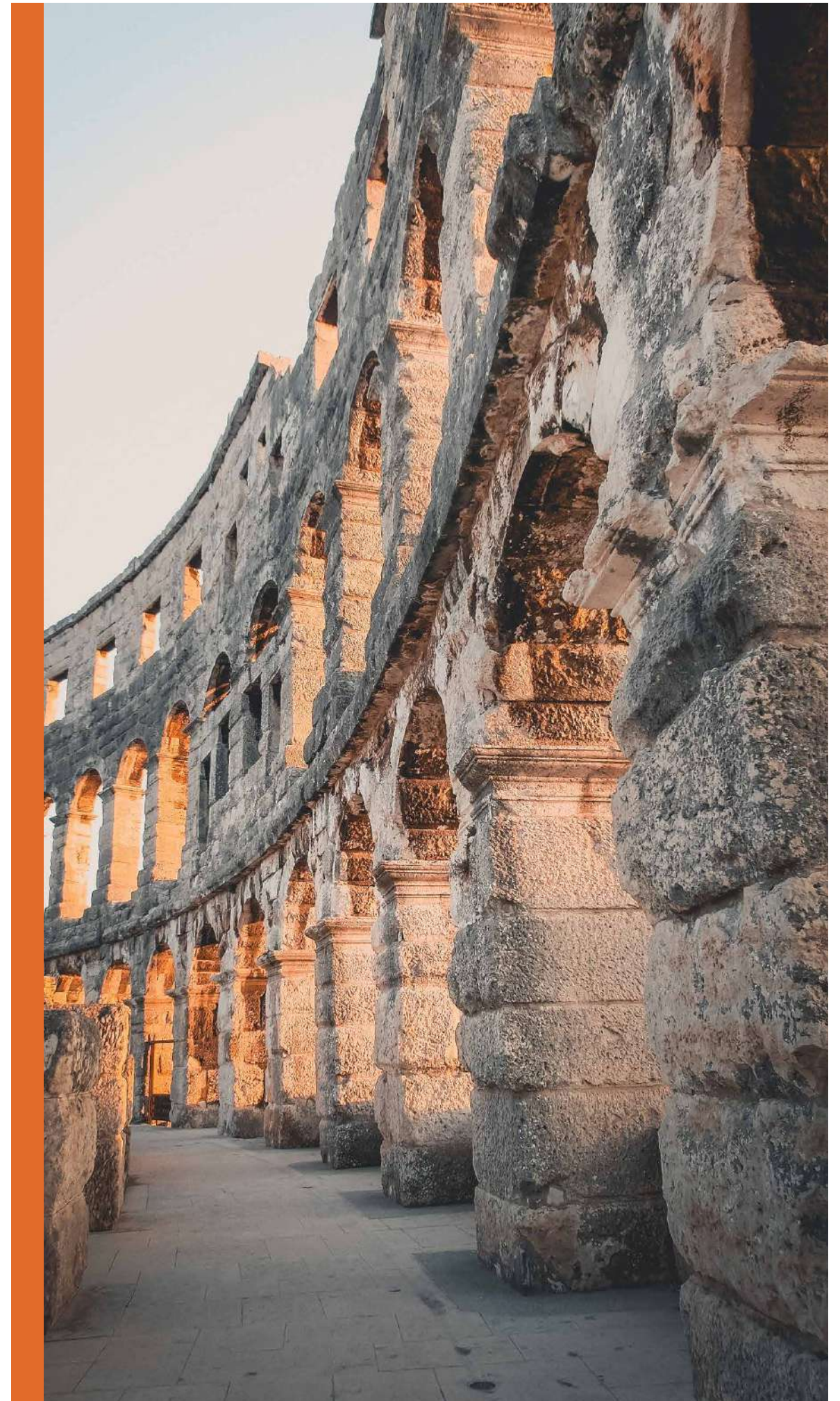



OBISPA.

COLEÇÃO •

## FIRENZE

Firenze é a nova coleção Obispa de cabides, maçanetas, puxadores e manilhões, que evoca a explosão artística daquele que foi o berço renascentista da Itália. Mais que referência inspiracional para peças com arrojo estético, a escolha desse

destino é um regresso às nossas origens, pois a Obispa tem Firenze em seu DNA. A arquitetura e o traçado da cidade podem ser notados nas diferentes linhas que compõem a coleção e que recebem o nome dos ícones do Renascimento.





## Puxador Dante Liso

Ref	Dim	CC
151.044	30 x 158 x 35 mm	128 mm
151.047	30 x 190 x 35 mm	160 mm
151.050	30 x 222 x 35 mm	192 mm
151.053	30 x 254 x 35 mm	224 mm
151.056	30 x 350 x 35 mm	320 mm
151.059	30 x 478 x 35 mm	448 mm
151.062	30 x 542 x 35 mm	512 mm
151.065	30 x 574 x 35 mm	544 mm



## Puxador Dante Recartilha

Ref	Dim	CC
151.042	30 x 158 x 35 mm	128 mm
151.045	30 x 190 x 35 mm	160 mm
151.048	30 x 222 x 35 mm	192 mm
151.051	30 x 254 x 35 mm	224 mm
151.054	30 x 350 x 35 mm	320 mm
151.057	30 x 478 x 35 mm	448 mm
151.060	30 x 542 x 35 mm	512 mm
151.063	30 x 574 x 35 mm	544 mm



## Puxador Dante Couro

Ref	Dim	CC
151.043	30 x 158 x 35 mm	128 mm
151.046	30 x 190 x 35 mm	160 mm
151.049	30 x 222 x 35 mm	192 mm
151.052	30 x 254 x 35 mm	224 mm
151.055	30 x 350 x 35 mm	320 mm
151.058	30 x 478 x 35 mm	448 mm
151.061	30 x 542 x 35 mm	512 mm
151.064	30 x 574 x 35 mm	544 mm



### Couros / Leather / Cueros

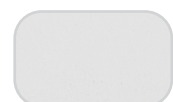

Branco / B



Cinza / CC



Preto / P



Areia / A



Café / C



Azul-marinho / AM

Dimensões:  
largura x comprimento x profundidade.  
width x length x depth.  
acho x largo x profundidad.  
CC: center-to-center // entre centros





## Puxador Ponte Vecchio

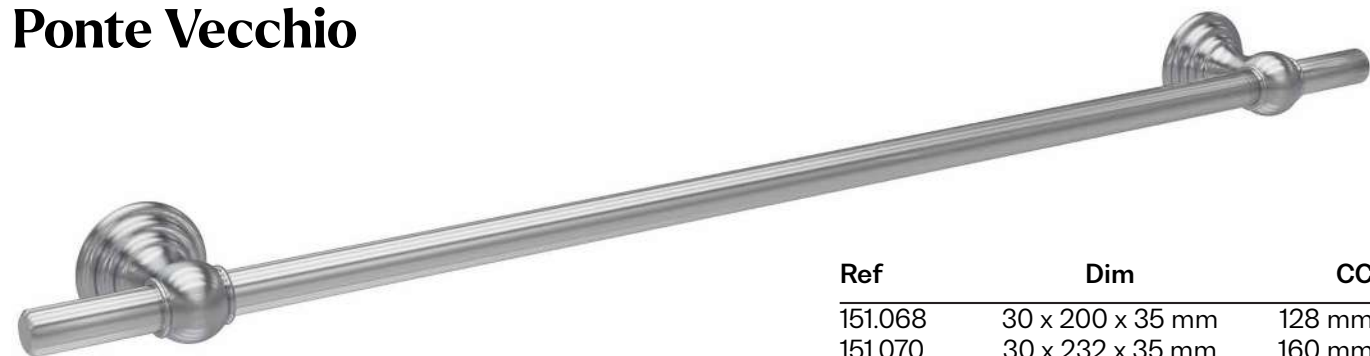

Ref	Dim	CC
151.068	30 x 200 x 35 mm	128 mm
151.070	30 x 232 x 35 mm	160 mm
151.072	30 x 264 x 35mm	192 mm
151.074	30 x 296 x 35mm	224 mm
151.076	30 x 392 x 35mm	320 mm
151.078	30 x 520 x 35mm	448 mm
151.080	30 x 584 x 35mm	512 mm
151.082	30 x 616 x 35mm	544 mm

## Puxador Ponte Vecchio Recartilha



Ref	Dim	CC
151.067	30 x 200 x 35 mm	128 mm
151.069	30 x 232 x 35 mm	160 mm
151.071	30 x 264 x 35mm	192 mm
151.073	30 x 296 x 35mm	224 mm
151.075	30 x 392 x 35mm	320 mm
151.077	30 x 520 x 35mm	448 mm
151.079	30 x 584 x 35mm	512 mm
151.081	30 x 616 x 35mm	544 mm





### Puxador Da Vinci Piccolo



Ref	Dim
151.099	44 x 44 x 32 mm

### Puxador Da Vinci Grande



Ref	Dim
151.100	70 x 70 x 32 mm

### Puxador Tizano Piccolo



Ref	Dim
151.097	35 x 35 x 25 mm

### Puxador Tizano Grande



Ref	Dim
151.098	70 x 70x 26 mm

### Puxador Michelangelo



Ref	Dim
151.041	30 x 30x 35 mm

**Dimensões:**  
largura x comprimento x profundidade.  
width x length x depth.  
acho x largo x profundidad.  
CC: center-to-center // entre centros







## Boticelli



### Liso

Ref	Dim	CC
-----	-----	----

151.088	30 x 60 x 14 mm	32 mm
151.094	45 x 90 x 14 mm	55 mm

### Couro

Ref	Dim	CC
-----	-----	----

151.087	30 x 60 x 14 mm	32 mm
151.093	45 x 90 x 14 mm	55 mm

### Recartilha

Ref	Dim	CC
-----	-----	----

151.086	30 x 60 x 14 mm	32 mm
151.092	45 x 90 x 14 mm	55 mm



### Liso

Ref	Dim	CC
-----	-----	----

151.085	60 x 60 x 15 mm	44 mm
151.091	90 x 90 x 15 mm	69 mm

### Couro

Ref	Dim	CC
-----	-----	----

151.084	60 x 60 x 15 mm	44 mm
151.090	90 x 90 x 15 mm	69 mm

### Recartilha

Ref	Dim	CC
-----	-----	----

151.083	60 x 60 x 15 mm	44 mm
151.089	90 x 90 x 15 mm	69 mm

### Couros / Leather / Cueros

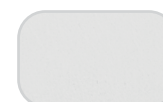

Branco / B



Cinza / CC



Preto / P



Areia / A



Café / C



Azul-marinho / AM

\* Vide Desenhos de Usinagem, páginas 86 a 89 do catálogo.

Dimensões:  
largura x comprimento x profundidade.  
width x length x depth.  
acho x largo x profundidad.  
CC: center-to-center // entre centros

Dimensões:  
largura x comprimento x profundidade.  
width x length x depth.  
acho x largo x profundidad.  
CC: center-to-center // entre centros





Desenvolvido especialmente para frentes de fogões, geladeiras e móveis robustos.



### Puxador Big Dante Liso

Ref	Dim	CC
200.159	51 x 211 x 59.5 mm	160 mm
200.162	51 x 243 x 59.5 mm	192 mm
200.165	51 x 275 x 59.5 mm	224 mm
200.168	51 x 371 x 59.5 mm	320 mm
200.171	51 x 501 x 59.5 mm	450 mm
200.174	51 x 563 x 59.5 mm	512 mm
200.177	51 x 595 x 59.5 mm	544 mm

### Puxador Big Dante Recartilha

Ref	Dim	CC
200.157	51 x 211 x 59.5 mm	160 mm
200.160	51 x 243 x 59.5 mm	192 mm
200.163	51 x 275 x 59.5 mm	224 mm
200.166	51 x 371 x 59.5 mm	320 mm
200.169	51 x 501 x 59.5 mm	450 mm
200.172	51 x 563 x 59.5 mm	512 mm
200.175	51 x 595 x 59.5 mm	544 mm

### Puxador Big Dante Couro

Ref	Dim	CC
200.158	51 x 211 x 59.5 mm	160 mm
200.161	51 x 243 x 59.5 mm	192 mm
200.164	51 x 275 x 59.5 mm	224 mm
200.167	51 x 371 x 59.5 mm	320 mm
200.170	51 x 501 x 59.5 mm	450 mm
200.173	51 x 563 x 59.5 mm	512 mm
200.176	51 x 595 x 59.5 mm	544 mm

#### Couros / Leather / Cueros

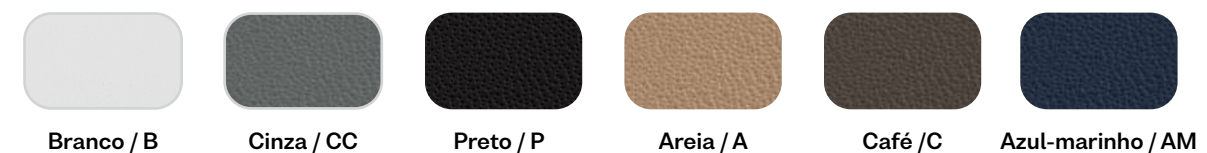

Dimensões:  
largura x comprimento x profundidade.  
width x length x depth.  
acho x largo x profundidad.  
CC: center-to-center // entre centros



## Manilhão Duomo



### Liso

Ref	Dim	Furação
200.126 AS	51 x 551 x 59.5 mm	500 mm
200.129 AD	51 x 551 x 59.5 mm	500 mm
200.132 AS	51 x 801 x 59.5 mm	750 mm
200.135 AD	51 x 801 x 59.5 mm	750 mm

### Recartilha

Ref	Dim	Furação
200.125 AS	51 x 551 x 59.5 mm	500 mm
200.128 AD	51 x 551 x 59.5 mm	500 mm
200.131 AS	51 x 801 x 59.5 mm	750 mm
200.134 AD	51 x 801 x 59.5 mm	750 mm

### Couro

Ref	Dim	Furação
200.127 AS	51 x 551 x 59.5 mm	500 mm
200.130 AD	51 x 551 x 59.5 mm	500 mm
200.133 AS	51 x 801 x 59.5 mm	750 mm
200.136 AD	51 x 801 x 59.5 mm	750 mm

### Couros / Leather / Cueros

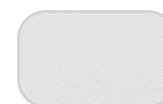

Branco / B



Cinza / CC



Preto / P



Areia / A



Café / C



Azul-marinho / AM

#### Dimensões:

largura x comprimento x profundidade.  
width x length x depth.  
acho x largo x profundidad.  
CC: center-to-center // entre centros



## Manilhão Doppio Duomo



### Liso

Ref	Dim	Furação
200.138 AS	51 x 1051 x 59.5 mm	1 mm (500/500)
200.141 AD	51 x 1051 x 59.5 mm	1 mm (500/500)
200.144 AS	51 x 1551 x 59.5 mm	1,5 mm (750/750)
200.147 AD	51 x 1551 x 59.5 mm	1,5 mm (750/750)

### Couro

Ref	Dim	Furação
200.139 AS	51 x 1051 x 59.5 mm	1 mm (500/500)
200.142 AD	51 x 1051 x 59.5 mm	1 mm (500/500)
200.145 AS	51 x 1551 x 59.5 mm	1,5 mm (750/750)
200.148 AD	51 x 1551 x 59.5 mm	1,5 mm (750/750)

### Recartilha

Ref	Dim	Furação
200.137 AS	51 x 1051 x 59.5 mm	1 mm (500/500)
200.140 AD	51 x 1051 x 59.5 mm	1 mm (500/500)
200.143 AS	51 x 1551 x 59.5 mm	1,5 mm (750/750)
200.146 AD	51 x 1551 x 59.5 mm	1,5 mm (750/750)

### Couros / Leather / Cueros



Branco / B



Cinza / CC



Preto / P



Areia / A



Café / C



Azul-marinho / AM







**Cabide  
Donatello  
Piccolo**



Ref	Dim
300.029	44 x 44 x 34,5 mm

**Cabide  
Donatello  
Grande**



Ref	Dim
300.030	70 x 70 x 34,5 mm

**Dimensões:**  
largura x comprimento x profundidade.  
width x length x depth.  
acho x largo x profundidad.  
CC: center-to-center // entre centros





## Maçaneta Firenze



### Lisa

Ref	Dim	Abertura
422.005	142 x 122 x 70 mm	Europetil
422.001	142 x 122 x 70 mm	Externa G 34,5 x 18
422.002	142 x 122 x 70 mm	Externa 30,5 x 16
422.003	142 x 122 x 70 mm	Interna 22 x 7,5
422.004	142 x 122 x 70 mm	Tranqueta

### Couro

Ref	Dim	Abertura
424.005	142 x 122 x 70 mm	Europetil
424.001	142 x 122 x 70 mm	Externa G 34,5 x 18
424.002	142 x 122 x 70 mm	Externa 30,5 x 16
424.003	142 x 122 x 70 mm	Interna 22 x 7,5
424.004	142 x 122 x 70 mm	Tranqueta

### Recartilha

Ref	Dim	Abertura
423.005	142 x 122 x 70 mm	Europetil
423.001	142 x 122 x 70 mm	Externa G 34,5 x 18
423.002	142 x 122 x 70 mm	Externa 30,5 x 16
423.003	142 x 122 x 70 mm	Interna 22 x 7,5
423.004	142 x 122 x 70 mm	Tranqueta

### Couros / Leather / Cueros

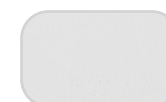

Branco / B



Cinza / CC



Preto / P



Areia / A



Café / C



Azul-marinho / AM

**Dimensões:**  
 largura x comprimento x profundidade.  
 width x length x depth.  
 ancho x largo x profundidad.  
 CC: center-to-center // entre centros



# LINHA • VÊNETO

As sete províncias italianas do Vêneto são a inspiração para a linha de puxadores concha e ponto que tem a estética romântica como essência. É uma coleção de traços curvos que expressam a espontaneidade

das cidades vênetas e, assim como a pluralidade cultural de suas comunas, os acessórios dessa linha têm fácil aplicação em projetos de décor clássico, retrô, vintage ou industrial.



## Pádua

Ref	Dim	CC
100.785	46 x 92 x 30 mm	64 mm
100.786	47 x 129 x 30 mm	96 mm

## Belluno

Ref	Dim	CC
100.793	46 x 92 x 30 mm	64 mm
100.794	47 x 129 x 30 mm	96 mm

## Veneza

Ref	Dim	CC
100.783	36 x 72 x 25 mm	32 mm
100.784	46 x 102 x 30 mm	64 mm

## Rovigo



Ref	Dim
100.791	80 x 80 x 33,8 mm
100.792	45 x 45 x 21,5 mm

## Vicenza



Ref	Dim
100.789	80 x 80 x 33,8 mm
100.790	45 x 45 x 21,5 mm

**Dimensões:**  
largura x comprimento x profundidade.  
width x length x depth.  
acho x largo x profundidad.  
CC: center-to-center // entre centros



## LINHA • DUAL

A Linha Dual traz a justa medida entre a versatilidade do estilo industrial e o refúgio que se espera de casa nos dias de hoje. O resultado é uma coleção de puxadores, manilhões, maçanetas cabides com facilidade de aplicação e alto rigor estético.

Os acessórios com acabamento clássico, recartilhado e em couro foram concebidos para estar em destaque, tornando-se uma rica parte do mobiliário.



## Big Dual Couro



Ref	Dim	CC
200.118	22,5 x 187 x 61 mm	160 mm
200.119	22,5 x 219 x 61 mm	192 mm
200.120	22,5 x 251 x 61 mm	224 mm
200.121	22,5 x 347 x 61 mm	320 mm
200.117	22,5 x 477 x 61 mm	450 mm
200.122	22,5 x 539 x 61 mm	512 mm

## Big Dual Recartilha

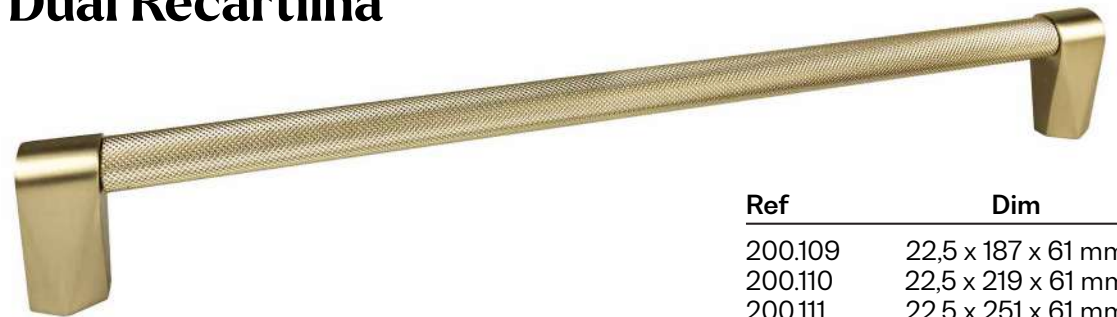

Ref	Dim	CC
200.109	22,5 x 187 x 61 mm	160 mm
200.110	22,5 x 219 x 61 mm	192 mm
200.111	22,5 x 251 x 61 mm	224 mm
200.112	22,5 x 347 x 61 mm	320 mm
200.104	22,5 x 477 x 61 mm	450 mm
200.113	22,5 x 539 x 61 mm	512 mm

### Couros / Leather / Cueros



Disponíveis em todas as pinturas e nas seguintes combinações.  
Available in all paintings and in the following.  
Disponible en todas las pinturas y en las siguientes combinaciones.

Cód.	Ponteira	Barra	Cód.	Post	Bar	Cód.	Soporte	Barra
34	Cromo Escovado	Cromo	34	Santin Chrome	Chrome	34	Cromo Cepillado	Cromo
53	Níquel Escovado	Níquel	53	Santin Níquel	Níquel	53	Níquel Cepillado	Níquel
371	Ouro Escovado	Ouro	371	Santin Gold	Gold	371	Oro Cepillado	Ouro
260	Black Silk	Níquel Negro	260	Black Silk	Black Nickel	260	Black Silk	Níquel Negro

**Dimensões:**  
largura x comprimento x profundidade.  
width x length x depth.  
acho x largo x profundidad.  
CC: center-to-center // entre centros



## Dual Recartilha

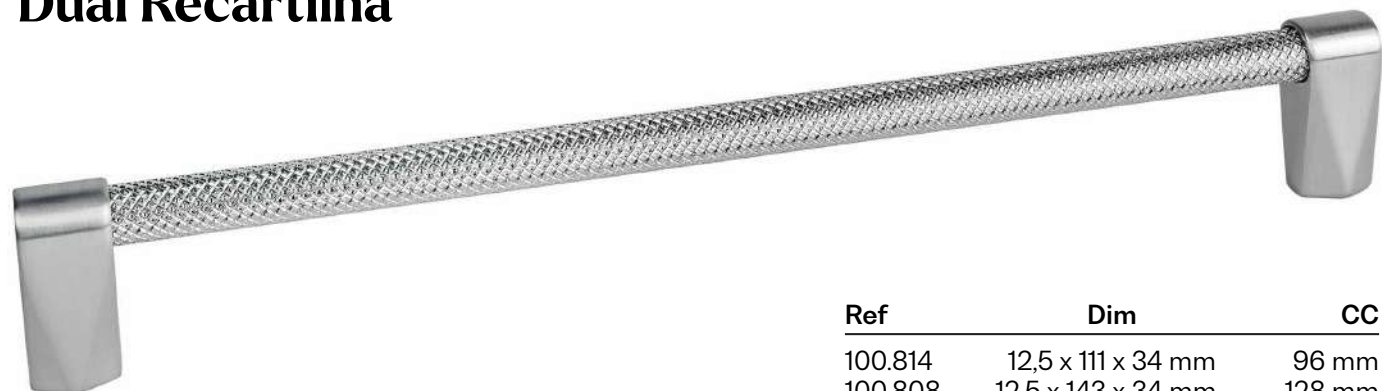

Ref	Dim	CC
100.814	12,5 x 111 x 34 mm	96 mm
100.808	12,5 x 143 x 34 mm	128 mm
100.796	12,5 x 175 x 34 mm	160 mm
100.810	12,5 x 207 x 34 mm	192 mm
100.797	12,5 x 239 x 34 mm	224 mm
100.798	12,5 x 335 x 34 mm	320 mm
100.799	12,5 x 463 x 34 mm	448 mm
100.809	12,5 x 527 x 34 mm	512 mm

## Mini Dual Recartilha Barra



Ref	Dim
150.981	12,5 x 55 x 34 mm

## Dual Couro



Ref	Dim	CC
100.811	12,5 x 143 x 34 mm	128 mm
100.800	12,5 x 175 x 34 mm	160 mm
100.812	12,5 x 207 x 34 mm	192 mm
100.801	12,5 x 239 x 34 mm	224 mm
100.802	12,5 x 335 x 34 mm	320 mm
100.803	12,5 x 463 x 34 mm	448 mm
100.813	12,5 x 527 x 34 mm	512 mm

## Mini Dual

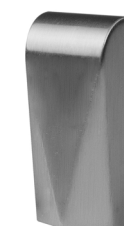

Ref	Dim
100.807	12,5 x 15 x 34 mm

### Couros / Leather / Cueros



Disponíveis em todas as pinturas e nas seguintes combinações.  
Available in all paintings and in the following.  
Disponible en todas las pinturas y en las siguientes combinaciones.

Cód.	Ponteira	Barra	Cód.	Post	Bar	Cód.	Soporte	Barra
34	Cromo Escovado	Cromo	34	Santin Chrome	Chrome	34	Cromo Cepillado	Cromo
53	Níquel Escovado	Níquel	53	Santin Níquel	Níquel	53	Níquel Cepillado	Níquel
371	Ouro Escovado	Ouro	371	Santin Gold	Gold	371	Oro Cepillado	Oro
260	Black Silk	Níquel Negro	260	Black Silk	Black Nickel	260	Black Silk	Níquel Negro

Dimensões:  
largura x comprimento x profundidade.  
width x length x depth.  
acho x largo x profundidad.  
CC: center-to-center // entre centros





OBISPA.

LINHA • **IZZIE**

O Canadá é representado na mesma medida pela civilidade urbana e sua natureza exuberante. São lados opostos da mesma cultura que se conectam por

pontes imponentes que servem de inspiração para os puxadores da Linha Izzie. Longilíneas, estão disponíveis em acabamento liso e recartilhado.





## Izzie

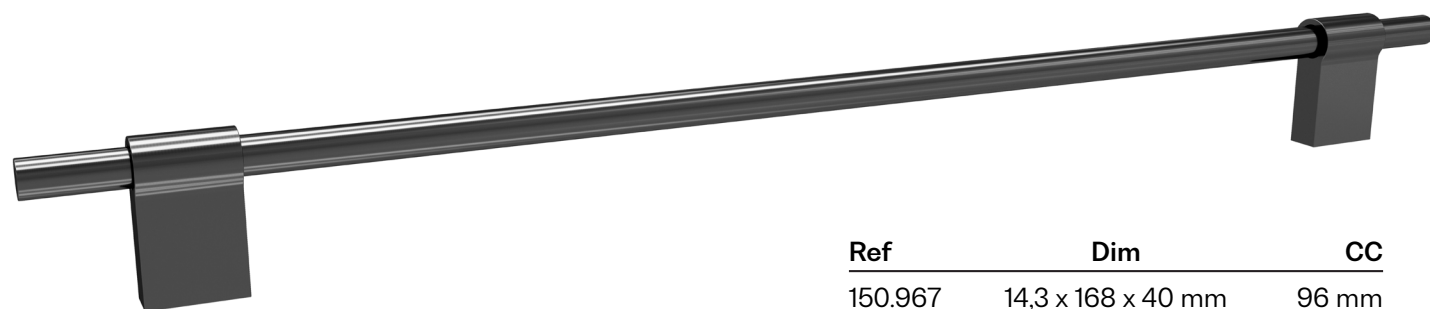

Ref	Dim	CC
150.967	14,3 x 168 x 40 mm	96 mm
150.968	14,3 x 232 x 40 mm	160 mm
150.969	14,3 x 296 x 40 mm	224 mm
150.970	14,3 x 424 x 40 mm	352 mm

## Mini Izzie

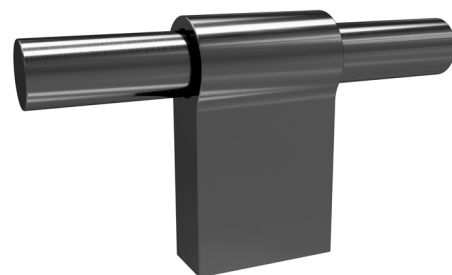

Ref	Dim
150.966	14,3 x 72 x 40 mm

Disponíveis em todas as pinturas e nas seguintes combinações.  
Available in all paintings and in the following.  
Disponible en todas las pinturas y en las siguientes combinaciones.

Cód.	Ponteira	Barra	Cód.	Post	Bar	Cód.	Soporte	Barra
34	Cromo Escovado	Cromo	34	Santin Chrome	Chrome	34	Cromo Cepillado	Cromo
53	Níquel Escovado	Níquel	53	Santin Nikel	Nickel	53	Níquel Cepillado	Níquel
371	Ouro Escovado	Ouro	371	Santin Gold	Gold	371	Oro Cepillado	Oro
260	Black Silk	Níquel Negro	260	Black Silk	Black Nickel	260	Black Silk	Níquel Negro

**Dimensões:**  
largura x comprimento x profundidade.  
width x length x depth.  
acho x largo x profundidad.  
CC: center-to-center // entre centros

## Izzie Recartilha



Ref	Dim	CC
150.972	14,3 x 168 x 40 mm	96 mm
150.973	14,3 x 232 x 40 mm	160 mm
150.974	14,3 x 296 x 40 mm	224 mm
150.975	14,3 x 424 x 40 mm	352 mm

## Mini Izzie Recartilha



Ref	Dim
150.971	14,3 x 72 x 40 mm

Disponíveis em todas as pinturas e nas seguintes combinações.  
Available in all paintings and in the following.  
Disponible en todas las pinturas y en las siguientes combinaciones.

Cód.	Ponteira	Barra	Cód.	Post	Bar	Cód.	Soporte	Barra
34	Cromo Escovado	Cromo	34	Santin Chrome	Chrome	34	Cromo Cepillado	Cromo
53	Níquel Escovado	Níquel	53	Santin Nikel	Nickel	53	Níquel Cepillado	Níquel
371	Ouro Escovado	Ouro	371	Santin Gold	Gold	371	Oro Cepillado	Oro
260	Black Silk	Níquel Negro	260	Black Silk	Black Nickel	260	Black Silk	Níquel Negro

**Dimensões:**  
largura x comprimento x profundidade.  
width x length x depth.  
acho x largo x profundidad.  
CC: center-to-center // entre centros



## LINHA • QUEBEC

Quebec é um destino canadense inigualável, que ainda preserva suas origens francesas ao mesmo tempo em que oferece um cenário de tecnologia efervescente.

Essa justaposição de charme e vanguarda também inspira as peças da Linha Quebec, com uma estética minimalista e duradoura.

### Quebec



Ref	Dim	CC
150.952	18,5 x 178,5 x 38,2 mm	160 mm
150.953	18,5 x 242,5 x 38,2 mm	224 mm
150.954	18,5 x 338,5 x 38,2 mm	320 mm
150.955	18,5 x 466,5 x 38,2 mm	448 mm
150.956	18,5 x 562,5 x 38,2 mm	544 mm

### Mini Quebec



Ref	Dim
150.957	30 x 30 x 30 mm
150.958	35 x 35 x 30 mm



**Dimensões:**  
largura x comprimento x profundidade.  
width x length x depth.  
acho x largo x profundidad.  
CC: center-to-center // entre centros



## LINHA • TORONTO

A Toronto de hoje é a combinação de 140 diferentes etnias com suas múltiplas interferências sobre a arquitetura, a gastronomia e o modo de vida.

Assim como a cidade, as peças da Linha Toronto são vibrantes e

seguras. Suas linhas precisas imprimem um caráter de solidez a projetos que pedem uma estética básica e usual.

## Toronto



Ref	Dim	CC
150.947	8 x 116 x 41 mm	96 mm
150.948	8 x 180 x 41 mm	160 mm
150.949	8 x 244 x 41 mm	224 mm
150.950	8 x 340 x 41 mm	320 mm







### Affilato



Ref	Dim	CC
100.549	10 x 202 x 27 mm	192 mm
100.551	11 x 362 x 29 mm	352 mm

### Âmbar



Ref	Dim	CC
100.708	8 x 140 x 32 mm	128 mm
100.709	8 x 268 x 32 mm	256 mm
100.710	8 x 460 x 32 mm	448 mm

### Amplitu



Ref	Dim	CC
100.461	10 x 154 x 28 mm	128 mm
100.462	10 x 217 x 28 mm	192 mm
100.463	10 x 249 x 28 mm	224 mm
100.464	11 x 347 x 29 mm	320 mm
100.465	12 x 475 x 29 mm	448 mm
100.466	13 x 571 x 29 mm	544 mm

### Chamfer



Ref	Dim	CC
100.566	11 x 181 x 25 mm	160 mm
100.567	12 x 309 x 26 mm	288 mm
100.568	12 x 438 x 26 mm	416 mm

**Dimensões:**  
 largura x comprimento x profundidade.  
 width x length x depth.  
 ancho x largo x profundidad.  
 CC: center-to-center // entre centros



## Atlanta



Ref	Dim	CC
100.587	9 x 144 x 28 mm	128 mm
100.588	9 x 208 x 28 mm	192 mm
100.589	9 x 240 x 28 mm	224 mm

## Cisne



Ref	Dim	CC
100.717	22 x 208 x 65 mm	--

## Mini Atlanta



Ref	Dim
100.586	9 x 34 x 28 mm

## Cristallo

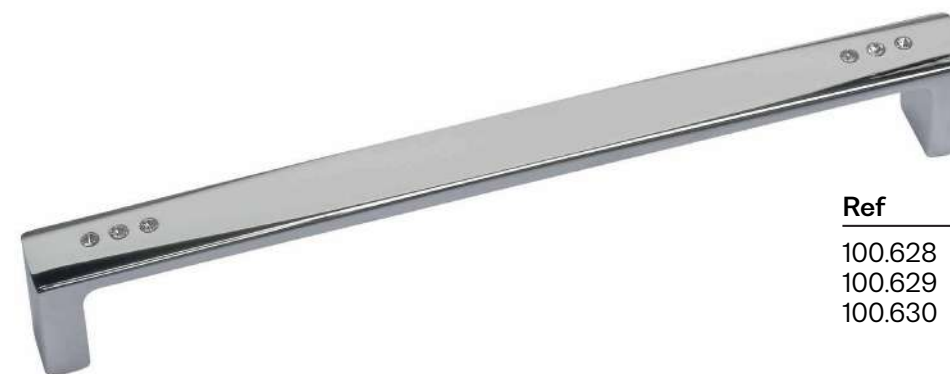

Ref	Dim	CC
100.628	14 x 168 x 25 mm	160 mm
100.629	14 x 360 x 26 mm	352 mm
100.630	14 x 552 x 28 mm	544 mm

## Charlô



Ref	Dim	CC
100.553	9 x 193 x 24 mm	160 mm
100.554	9 x 258 x 25 mm	224 mm
100.555	10 x 355 x 26 mm	320 mm
100.556	10 x 420 x 28 mm	384 mm

## Mini Cristallo



Ref	Dim
100.627	14 x 35 x 25 mm



## Frigo



Ref	Dim	CC
100.542	12 x 220 x 25 mm	160 mm
100.543	13 x 302 x 26 mm	224 mm

## Mini Frigo



Ref	Dim	CC
100.541	11 x 55 x 25 mm	16 mm

## Identifique-se



Ref	Dim	CC
100.664	18 x 143 x 27 mm	128 mm
100.665	18 x 239 x 27 mm	224 mm
100.666	18 x 335 x 27 mm	320 mm
100.667	20 x 559 x 29 mm	544 mm

## Limusine



Ref	Dim	CC
100.066	11 x 152 x 28 mm	128 mm
100.044	15 x 255 x 30 mm	224 mm
100.130	15 x 350 x 30 mm	320 mm

## Mono



Ref	Dim	CC
100.449	18 x 143 x 27 mm	128mm
100.370	18 x 175 x 27 mm	160 mm
100.450	18 x 239 x 27 mm	224 mm
100.451	18 x 335 x 27 mm	320 mm
100.691	20 x 559 x 29 mm	544 mm

## Ponto Mono



Ref	Dim
100.448	18 x 33 x 27 mm

**Dimensões:**  
largura x comprimento x profundidade.  
width x length x depth.  
acho x largo x profundidad.  
CC: entre centros // center-to-center.

**Dimensões:**  
largura x comprimento x profundidade.  
width x length x depth.  
acho x largo x profundidad.  
CC: entre centros // center-to-center.



## Quadro

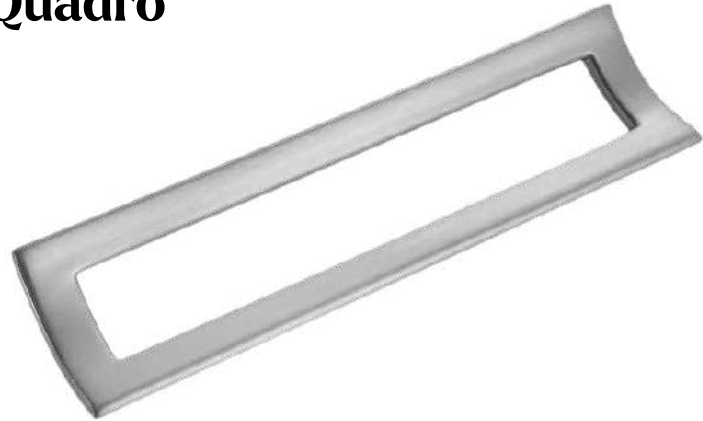

Ref	Dim	CC
100.236	37 x 140 x 30 mm	128 mm

## Mini Quadro



Ref	Dim	CC
100.237	37 x 43 x 30 mm	32 mm

## Safira

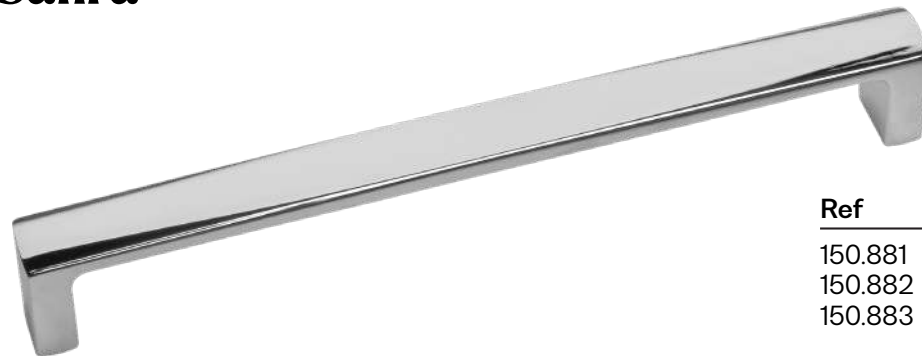

Ref	Dim	CC
150.881	14 x 168 x 25 mm	160 mm
150.882	14 x 360 x 26 mm	352 mm
150.883	14 x 552 x 28 mm	544 mm

## Mini Safira



Ref	Dim
150.880	14 x 35 x 25 mm

## Scarpe



Ref	Dim	CC
100.490	10 x 138 x 28 mm	128 mm
100.491	10 x 202 x 29 mm	192 mm
100.492	11 x 299 x 30 mm	288 mm
100.493	11 x 395 x 32 mm	384 mm
100.494	12 x 492 x 33 mm	480 mm

## Slim



Ref	Dim	CC
100.323	9 x 105 x 23 mm	96 mm
100.322	9 x 137 x 23 mm	128 mm
100.321	9 x 169 x 23 mm	160 mm
100.384	9 x 265 x 23 mm	256 mm
100.385	9 x 361 x 23 mm	352 mm

## Parma



Ref	Dim	CC
100.804	12,5 x 138 x 27 mm	128 mm
150.063	13 x 202 x 27 mm	192 mm
150.064	13 x 330 x 27 mm	320 mm

## Sense Resina



Ref	Dim	CC
100.631	13 x 202 x 27 mm	192 mm
100.632	13 x 330 x 27 mm	320 mm

Resina: branco (RB), café (RC) e preto (RP).  
 Resin: white (RB), brown (RC) and black (RP).  
 Resina: blanco (RB), café (RC) y negro (RP).

Dimensões:  
 largura x comprimento x profundidade.  
 width x length x depth.  
 acho x largo x profundidad.  
 CC: center-to-center // entre centros

Dimensões:  
 largura x comprimento x profundidade.  
 width x length x depth.  
 acho x largo x profundidad.  
 CC: center-to-center // entre centros



## Timeless



Ref	Dim	CC
100.624	9 x 195 x 28 mm	160 mm
100.625	9 x 366 x 29 mm	320 mm
100.626	10 x 542 x 32 mm	448-512 mm

## Mini Timeless



Ref	Dim
100.623	9 x 50 x 28 mm

## Ballare



Ref	Dim	CC
100.757D	52 x 100 x 10 mm	64 mm
<i>Espessura de porta / Doors thickness / Espesura de la puerta: até 22 mm</i>		
100.758D	52 x 170 x 10 mm	128 mm
<i>Espessura de porta / Doors thickness / Espesura de la puerta: até 20 mm</i>		



Ref	Dim	CC
100.757E	52 x 100 x 10 mm	64 mm
<i>Espessura de porta / Doors thickness / Espesura de la puerta: até 22 mm</i>		
100.758E	52 x 170 x 10 mm	128 mm
<i>Espessura de porta / Doors thickness / Espesura de la puerta: até 20 mm</i>		

## Aereo



Ref	Dim	CC
100.755	49 x 260 x 25 mm	180 mm

## Aereo Esquerdo



Ref	Dim	CC
100.754E	39 x 130 x 25 mm	115 mm

## Aereo Direito



Ref	Dim	CC
100.754D	39 x 130 x 25 mm	115 mm





## Bordo



Ref	Dim	CC
100.759	50 x 100 x 10 mm	64 mm
100.760	50 x 170 x 10 mm	128 mm

## Ingá



Ref	Dim	CC
150.980	15 x 120 x 25 mm	96 mm
100.711	15 x 200 x 25 mm	160 mm

Espessura de porta / Doors thickness / Espesura de la puerta: até 25 mm

150.581	15 x 200 x 18,5 mm	160 mm
---------	--------------------	--------

Espessura de porta / Doors thickness / Espesura de la puerta: até 18 mm

## Linea

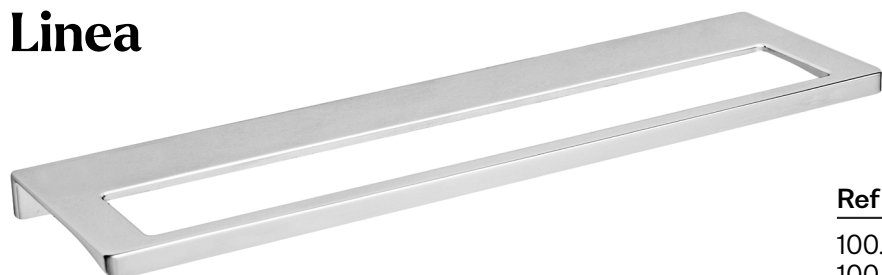

Ref	Dim	CC
100.761	50 x 100 x 10 mm	64 mm
100.762	50 x 170 x 10 mm	128 mm

## Pietra Liso



Ref	Dim	CC
100.779	21 x 230 x 21 mm	128 mm

\* Vide Desenhos de Usinagem, páginas 86 a 89 do catálogo.

**Dimensões:**  
largura x comprimento x profundidade.  
width x length x depth.  
acho x largo x profundidad.  
CC: center-to-center // entre centros

## Interface



Ref	Dim	CC
100.460	32 x 148 x 13 mm	128 mm
<i>Sem pega / Sliding door use / Solo para puertas deslizantes</i>		
100.552	48 x 278 x 17,5 mm	-----
<i>Com pega</i>		

\* Vide Desenhos de Usinagem, páginas 86 a 89 do catálogo.

## Moldue



Ref	Dim	CC
100.488	45 x 140 x 14 mm	128 mm (2)
100.489	45 x 203 x 14 mm	192 mm (2)
100.621	53 x 332 x 14 mm	320 mm (1)

## Moldue Couro



Ref	Dim	CC (2)
100.644	45 x 140 x 15 mm	128 mm (2)
100.645	45 x 203 x 15 mm	192 mm (1)
100.646	53 x 332 x 16 mm	320 mm

(1) Chapa remanchada e fixação lateral. (2) Chapa fixada com parafusos e fixação traseira.  
(1) Riveted back bracket with lateral fixation with screws. (2) Back brackets fixation made by screws. Back fixation.  
(1) Chapa remanchada y fijación lateral con tornillos.. (2) Chapa fijada con tornillos y fijación por detrás.

### Couros / Leather / Cueros

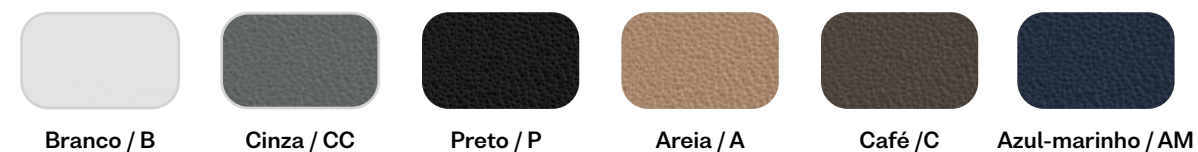

\* Vide Desenhos de Usinagem, páginas 86 a 89 do catálogo.

**Dimensões:**  
largura x comprimento x profundidade.  
width x length x depth.  
acho x largo x profundidad.  
CC: center-to-center // entre centros

## Ghost



Ref	Dim
100.612	45 x 100 x 14 mm
100.613	45 x 150 x 14 mm
100.614	45 x 300 x 14 mm
100.615	45 x 500 x 14 mm
100.616	45 x 700 x 14 mm
100.617	45 x 1000 x 14 mm

### Puxador em alumínio com ponteira em zamac

- 212 - Anodizado preto com ponteiras pretas
- 214 - Anodizado preto com ponteiras cromadas
- 215 - Anodizado natural fosco com ponteiras cromadas
- 216 - Anodizado natural fosco com ponteiras cor alumínio
- 222 - Pintura branca
- 223 - Pintura branca com ponteiras cromadas

#### Aluminium handle with zamac terminals

- 212 - Black anodized with black terminals
- 214 - Black anodized with chrome terminals
- 215 - Natural matte anodized with chrome terminals
- 216 - Natural matte anodized with aluminium terminals
- 222 - White painted
- 223 - White painted with chrome terminals

#### Tirador em alumínio y terminales em zamac

- 212 - Anodizado negro con terminales negros
- 214 - Anodizado negro con terminales cromados
- 215 - Anodizado natural mate con terminales cromados
- 216 - Anodizado natural mate con terminales aluminio
- 222 - Pintura blanca
- 223 - Pintura blanca con terminales cromados

\* Vide Desenhos de Usinagem, páginas 86 a 89 do catálogo.

## Occhi



Ref	Dim	CC
100.745	45 x 45 x 13 mm	32 mm

\* Vide Desenhos de Usinagem, páginas 86 a 89 do catálogo.





## Retrô Metal



Ref	Dim	CC
100.267	47 x 60 x 19 mm	48 mm
100.268	47 x 140 x 19 mm	128 mm

## Box



Ref	Dim
100.620	37 x 37 x 11 mm

## Ring



Ref	Dim
100.447	37 x 37 x 11 mm

\* Vide Desenhos de Usinagem, páginas 86 a 89 do catálogo.

## Punto



Ref	Dim
100.753	20 x 20 x 2,6 mm

Fixação por fita dupla face.

## Square



Ref	Dim	CC
100.642	40 x 40 x 22 mm	32 mm
100.643	75 x 75 x 25 mm	64 mm

Dimensões:  
largura x comprimento x profundidade.  
width x length x depth.  
acho x largo x profundidad.  
CC: center-to-center // entre centros

## Íris



Madrepérola

Ref	Dim	CC
100.700	21 x 81 x 26 mm	32 mm

## Cais



Ref	Dim	CC
100.496	22 x 22 x 20 mm	Ponto

## Coral

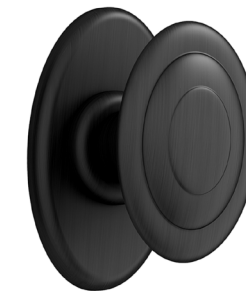

Ref	Dim
100.721	25 x 40 x 24 mm



## Dobra



Ref	Dim	CC
100.378	25 x 25 x 18 mm	Ponto
100.379	38 x 38 x 22 mm	16 mm

## Elle Ponto



Ref	Dim	CC
100.618	24 x 35 x 25 mm	16 mm

## Galli



Ref	Dim	CC
100.333	40 x 40 x 18 mm	16 mm

## Grava



Ref	Dim	CC
100.381	30 x 30 x 17 mm	Ponto
100.382	50 x 50 x 22 mm	16 mm

## Halli



Ref	Dim	CC
100.332	40 x 40 x 18 mm	32 mm

## Laca



Ref	Dim	CC
100.725	40 x 40 x 24 mm	32 mm
100.726	75 x 75 x 25 mm	64 mm

## Legno



Ref	Dim	CC
100.640	40 x 40 x 22 mm	32 mm
100.641	75 x 75 x 25 mm	64 mm

## Ramp



Ref	Dim	CC
100.334	27 x 27 x 22 mm	16 mm
100.335	41 x 41 x 22 mm	16 mm



## Rock



Ref	Dim
100.470	16 x 20 x 16 mm
100.471	22 x 25 x 22 mm

## Sita



Ref	Dim
100.681	55 x 25 x 25,5 mm

## Soffi



Ref	Dim
100.674	20 x 20 x 25 mm

## Vídeo



Ref	Dim
100.072	36 x 24 x 23 mm

**Dimensões:**  
largura x comprimento x profundidade.  
width x length x depth.  
acho x largo x profundidad.  
CC: center-to-center // entre centros

## Passe



Ref	Dim	CC
100.366	31 x 184 x 13 mm	160 mm

## Mini Passe



Ref	Dim	CC
100.365	56 x 31 x 13 mm	16 mm

### Couros / Leather / Cueros

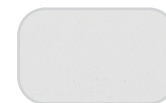

Branco / B



Cinza / CC



Preto / P



Areia / A



Café / C



Azul-marinho / AM

## Zen



Ref	Dim
100.108	13,5 x 22,5 x 40 mm

**Dimensões:**  
largura x comprimento x profundidade.  
width x length x depth.  
acho x largo x profundidad.  
CC: center-to-center // entre centros

## Supremo



Ref	Dim	CC
100.116	25 x 172 x 35 mm	128 mm
100.204	25 x 268 x 35 mm	224 mm

## Mini Supremo



Ref	Dim	CC
100.115	25 x 77 x 35 mm	16 mm

## Tartã



Ref	Dim	CC
100.572	60 x 60 x 24 mm	32 mm

## Tartã Couro

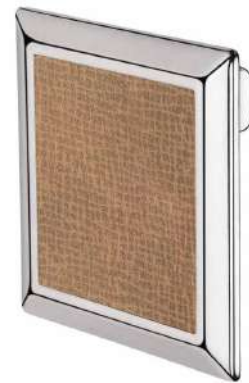

Ref	Dim	CC
100.573	60 x 60 x 24 mm	32 mm

### Couros / Leather / Cueros

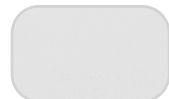

Branco / B



Cinza / CC



Preto / P



Areia / A



Café / C



Azul-marinho / AM

Dimensões:  
largura x comprimento x profundidade.  
width x length x depth.  
acho x largo x profundidad.  
CC: center-to-center // entre centros

## OBISPA.

## COLEÇÃO • MANILHÕES





## Manilhão Big Elle



Ref	Dim	CC
*200.045 AS	31 x 350 x 60 mm	320 mm
*200.044 AD	31 x 350 x 60 mm	320 mm
*200.011 AS	31 x 530 x 60 mm	500 mm
*200.008 AD	31 x 530 x 60 mm	500 mm
*200.179 AS	31 x 632 x 60 mm	600 mm
*200.184 AD	31 x 632 x 60 mm	600 mm
*200.183 AS	31 x 750 x 60 mm	718 mm
*200.182 AD	31 x 750 x 60 mm	718 mm
*200.116 AD	31 x 754 x 60 mm	724 mm
200.185 AS	31 x 832 x 60 mm	800 mm
200.186 AD	31 x 832 x 60 mm	800 mm
200.012 AS	31 x 1030 x 60 mm	1000 mm
200.009 AD	31 x 1030 x 60 mm	1000 mm
200.013 AS	31 x 1530 x 60 mm	1500 mm
200.010 AD	31 x 1530 x 60 mm	1500 mm

AD: Alça Dupla - AS: Alça Simples  
AD: Double - AS: Single // AD: Alsa Dupla - AS: Alsa Simple

\* Item com possibilidade de receber banho Galvânico.  
Disponíveis em todas as pinturas e nas seguintes combinações.  
Available in all paintings and in the following.  
Disponible en todas las pinturas y en las siguientes combinaciones.

Cód.	Tube	Ponteira
102	Black Silk	Black Silk
147	Ouro Escovado	Ouro Escovado
179	Aço Inox Escovado	Cromo
180	Aço Inox Escovado	Cromo Escovado
226	Aço Inox Polido	Cromo
227	Aço Inox Polido	Cromo Escovado

Cód.	Tube	Terminals	Cód.	Tube	Terminals
102	Black Silk	Black Silk	102	Black Silk	Black Silk
147	Satin Gold	Satin Gold	147	Oro Cepillado	Oro Cepillado
179	Satin Stainless Steel	Chrome	179	Acero Inox Cepillado	Cromo
180	Satin Stainless Steel	Satin Chrome	180	Acero Inox Cepillado	Cromo Cepillado
226	Polish Stainless Steel	Chrome	226	Acero Inox Pulido	Cromo
227	Polish Stainless Steel	Satin Chrome	227	Acero Inox Pulido	Cromo Cepillado

**Dimensões:**  
largura x comprimento x profundidade.  
width x length x depth.  
acho x largo x profundidad.  
CC: center-to-center // entre centros

## Manilhão Big Elle Duplo



Ref	Dim	CC
200.108 AS	31 x 1146 x 60 mm	308,4/497,3/308,4
200.114 AS	31 x 844,8 x 60 mm	406,4/406,4
200.115 AS	31 x 946,4 x 60 mm	457,2/457,2
200.098 AS	31 x 1030 x 60 mm	500/500
200.100 AD	31 x 1030 x 60 mm	500/500
200.107 AS	31 x 1145,6 x 60 mm	557/557
200.103 AS	31 x 1251 x 60 mm	609,6/609,6
200.099 AS	31 x 1530 x 60 mm	735/735
200.101 AD	31 x 1530 x 60 mm	735/735

AD: Alça Dupla - AS: Alça Simples  
AD: Double - AS: Single // AD: Alsa Dupla - AS: Alsa Simple

Disponíveis em todas as pinturas e nas seguintes combinações.  
Available in all paintings and in the following.  
Disponible en todas las pinturas y en las siguientes combinaciones.

Cód.	Tube	Ponteira
102	Black Silk	Black Silk
147	Ouro Escovado	Ouro Escovado
179	Aço Inox Escovado	Cromo
180	Aço Inox Escovado	Cromo Escovado
226	Aço Inox Polido	Cromo
227	Aço Inox Polido	Cromo Escovado

Cód.	Tube	Terminals	Cód.	Tube	Terminals
102	Black Silk	Black Silk	102	Black Silk	Black Silk
147	Satin Gold	Satin Gold	147	Oro Cepillado	Oro Cepillado
179	Satin Stainless Steel	Chrome	179	Acero Inox Cepillado	Cromo
180	Satin Stainless Steel	Satin Chrome	180	Acero Inox Cepillado	Cromo Cepillado
226	Polish Stainless Steel	Chrome	226	Acero Inox Pulido	Cromo
227	Polish Stainless Steel	Satin Chrome	227	Acero Inox Pulido	Cromo Cepillado

**Dimensões:**  
largura x comprimento x profundidade.  
width x length x depth.  
acho x largo x profundidad.  
CC: center-to-center // entre centros



## Manilhão Latto

Ref	Dim	CC
200.003 AD	60 x 284 x 58 mm	240 mm
200.018 AS	60 x 284 x 58 mm	240 mm

AD: Alça Dupla - AS: Alça Simples  
AD: Double - AS: Single // AD: Alsa Dupla - AS: Alsa Simple



## Manilhão Manno

Ref	Dim	CC
200.004 AD	30 x 266 x 64 mm	240 mm
200.019 AS	30 x 266 x 64 mm	240 mm

AD: Alça Dupla - AS: Alça Simples  
AD: Double - AS: Single // AD: Alsa Dupla - AS: Alsa Simple

## Manilhão Doppio Cisne



Ref	Dim	CC
200.092 AS	42 x 270 x 67 mm	240 mm

AD: Alça Dupla - AS: Alça Simples  
AD: Double - AS: Single // AD: Alsa Dupla - AS: Alsa Simple

Aplicação em portas de madeira  
Wooden doors / Para puertas de madeira

Sem abertura para máquina  
Does not have hole for keys / No hay abertura para llaves

## Manilhão Onda



Ref	Dim	CC
200.094	17 x 368 x 30 mm	288 mm

Dimensões:  
largura x comprimento x profundidade.  
width x length x depth.  
acho x largo x profundidad.  
CC: center-to-center // entre centros



## Manilhão Otto



Ref	Dim	CC	Abertura
200.057 AD	78 x 600 x 54 mm	580 mm	34,5 x 18 mm
200.059 AD	78 x 600 x 54 mm	580 mm	30,5 x 16 mm
200.060 AS	78 x 600 x 54 mm	580 mm	-----
200.061 AD	78 x 600 x 54 mm	580 mm	-----
200.078 AD	78 x 600 x 54 mm	580 mm	33,5 x 17,5mm Europerfil

AD: Alça Dupla - AS: Alça Simples  
AD: Double - AS: Single // AD: Alsa Dupla - AS: Alsa Simple

## Manilhão Verso



Ref	Dim	CC	Abertura
200.051 AD	43 x 600 x 44 mm	580 mm	34,5 x 18 mm
200.053 AD	43 x 600 x 44 mm	580 mm	30,5 x 16 mm
200.054 AS	43 x 600 x 44 mm	580 mm	-----
200.055 AD	43 x 600 x 44 mm	580 mm	-----
200.077 AD	43 x 600 x 44 mm	580 mm	33,5 x 17,5mm Europerfil

AD: Alça Dupla - AS: Alça Simples  
AD: Double - AS: Single // AD: Alsa Dupla - AS: Alsa Simple

## Manilhão Dual Recartilha



Ref	Dim	CC
200.106 AS	22,5 x 527 x 61 mm	500 mm
200.105 AD	22,5 x 527 x 61 mm	500 mm

AD: Alça Dupla - AS: Alça Simples  
AD: Double - AS: Single // AD: Alsa Dupla - AS: Alsa Simple

## Manilhão Dual Couro



Ref	Dim	CC
200.123 AS	22,5 x 527 x 61 mm	500 mm
200.124 AD	22,5 x 527 x 61 mm	500 mm

AD: Alça Dupla - AS: Alça Simples  
AD: Double - AS: Single // AD: Alsa Dupla - AS: Alsa Simple

### Couros / Leather / Cueros



Disponíveis em todas as pinturas e nas seguintes combinações.  
Available in all paintings and in the following.  
Disponible en todas las pinturas y en las siguientes combinaciones.

Cód.	Ponteira	Barra	Cód.	Post	Bar	Cód.	Soporte	Barra
34	Cromo Escovado	Cromo	34	Santin Chrome	Chrome	34	Cromo Cepillado	Cromo
53	Níquel Escovado	Níquel	53	Santin Níquel	Níquel	53	Níquel Cepillado	Níquel
371	Ouro Escovado	Ouro	371	Santin Gold	Gold	371	Oro Cepillado	Ouro
260	Black Silk	Níquel Negro	260	Black Silk	Black Nickel	260	Black Silk	Níquel Negro

COLEÇÃO • **CABIDES**

**Copacabana**



<u>Ref</u>	<u>Dim</u>
300.002	31 x 170 x 82 mm



**Copacabana  
Dual**



<u>Ref</u>	<u>Dim</u>
300.028	31 x 170 x 82 mm





## Seventy Dual



Ref	Dim
300.027	33 x 48 x 48 mm

## Mini Seventy Dual



Ref	Dim
300.026	33 x 32 x 44 mm

## Seventy Metal



Ref	Dim
300.010	33 x 48 x 48 mm

## Mini Seventy Metal



Ref	Dim
300.004	33 x 32 x 44 mm

Dimensões:  
 largura x comprimento x profundidade.  
 width x length x depth.  
 ancho x largo x profundidad.  
 CC: center-to-center // entre centros  
 Abertura: latch opening // abertura para máquina



**Classic**



Ref	Dim
300.012	48 x 20 x 126 mm

**Mini Classic**



Ref	Dim
300.005	45,5 x 25 x 53 mm



**Beta**



Ref	Dim
300.014	43 x 34 x 62 mm

**Filo**



Ref	Dim
300.013	38 x 32 x 82 mm

**Marine**



Ref	Dim
300.024	108 x 144 x 35 mm



OBISPA.

COLEÇÃO • **MAÇANETAS**

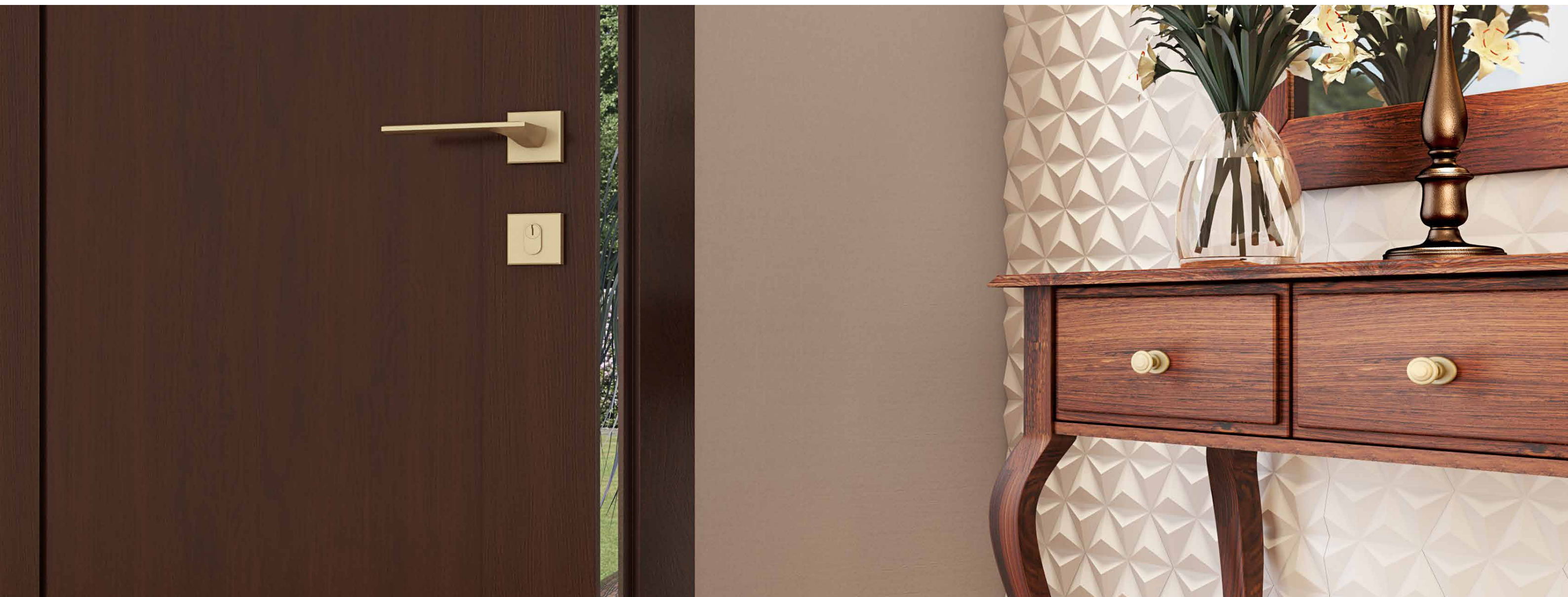

## Dual

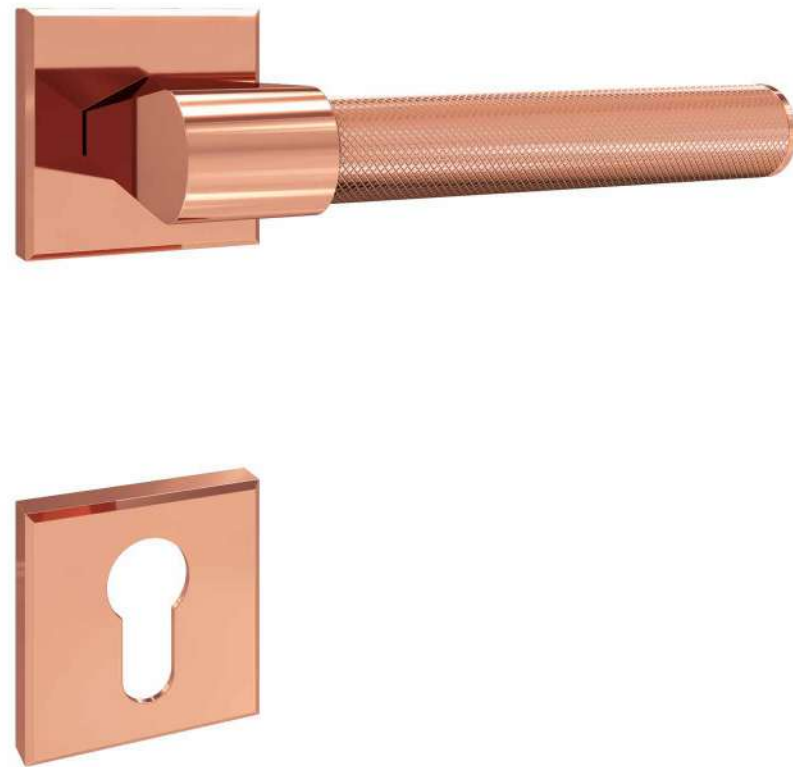

**Externa G**  
Exterior G  
419.011

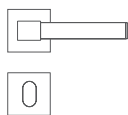

**Externa P**  
Exterior P  
419.012

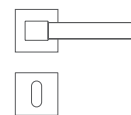

**Interna**  
Interior  
419.013

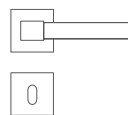

**Externa**  
Exterior  
419.015

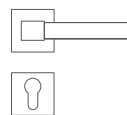

**Tranca para Banheiro**  
For Bath/Para Baños  
419.014

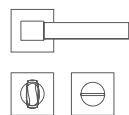

## Basic



**Externa G**  
Exterior G  
406.001

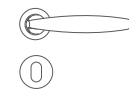

**Externa P**  
Exterior P  
406.002

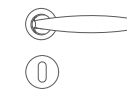

**Interna**  
Interior  
406.003

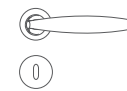

**Externa**  
Exterior  
406.005

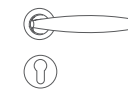

**Externa G**  
Exterior G  
406.011

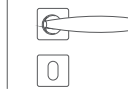

**Externa P**  
Exterior P  
406.012

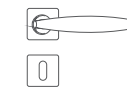

**Interna**  
Interior  
406.013

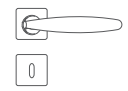

**Externa**  
Exterior  
406.015

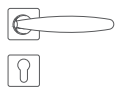

**Externa P**  
Exterior P  
406.021

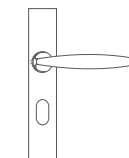

**Interna**  
Interior  
406.022

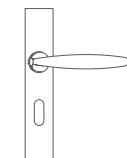

**Externa**  
Exterior  
406.023

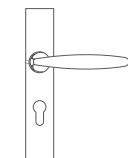

**Interna**  
Interior  
406.024

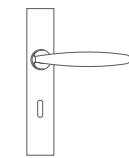

**Tranca para Banheiro**  
For Bath/Para Baños  
406.004 | 406.006

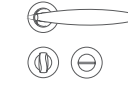

**Tranca para Banheiro**  
For Bath/Para Baños  
406.014 | 406.016

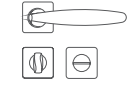

**Tranca para Banheiro**  
For Bath/Para Baños  
406.025 | 406.026

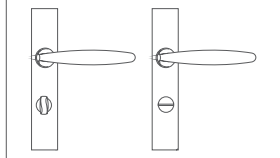



## Cristallo

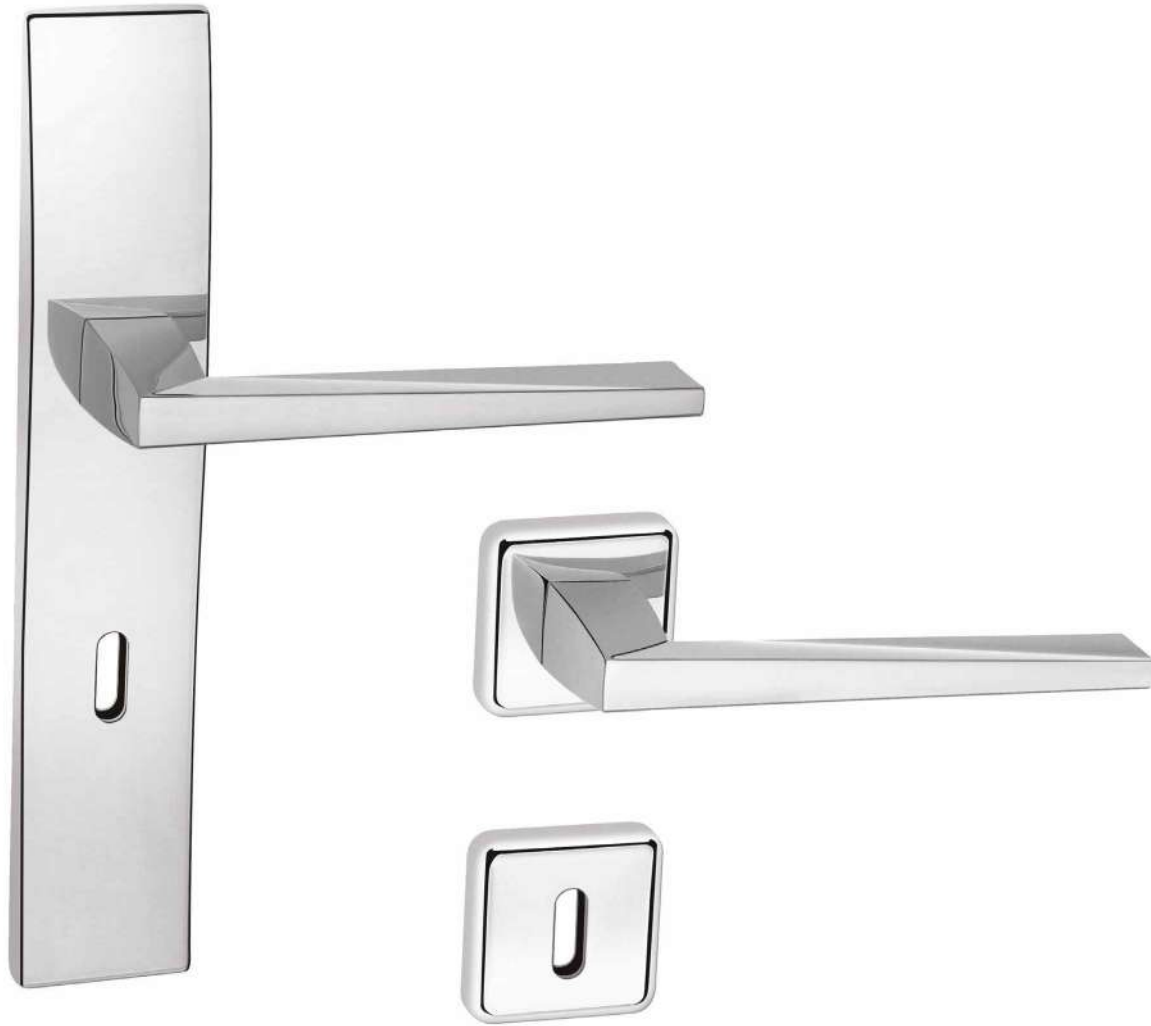

<b>Externa G</b> Exterior G 410.001	<b>Externa P</b> Exterior P 410.002	<b>Interna</b> Interior 410.003	<b>Externa</b> Exterior 410.005	<b>Externa G</b> Exterior G 410.011	<b>Externa P</b> Exterior P 410.012	<b>Interna</b> Interior 410.013	<b>Externa</b> Exterior 410.015

<b>Externa P</b> Exterior P 410.021	<b>Interna</b> Interior 410.022	<b>Externa</b> Exterior 410.023	<b>Interna</b> Interior 410.024	<b>Tranca para Banheiro</b> For Bath/Para Baños 410.004   410.006	<b>Tranca para Banheiro</b> For Bath/Para Baños 410.014   410.016	<b>Tranca para Banheiro</b> For Bath/Para Baños 410.025   410.026

## Milla



<b>Externa G</b> Exterior G 414.001	<b>Externa P</b> Exterior P 414.002	<b>Interna</b> Interior 414.003	<b>Externa</b> Exterior 414.005	<b>Externa G</b> Exterior G 414.011	<b>Externa P</b> Exterior P 414.012	<b>Interna</b> Interior 414.013	<b>Externa</b> Exterior 414.015

<b>Externa P</b> Exterior P 414.021	<b>Interna</b> Interior 414.022	<b>Externa</b> Exterior 414.023	<b>Interna</b> Interior 414.024	<b>Tranca para Banheiro</b> For Bath/Para Baños 414.004   414.006	<b>Tranca para Banheiro</b> For Bath/Para Baños 414.014   414.016	<b>Tranca para Banheiro</b> For Bath/Para Baños 414.025   414.026

# Wing



<b>Externa G</b> Exterior G 408.001	<b>Externa P</b> Exterior P 408.002	<b>Interna</b> Interior 408.003	<b>Externa</b> Exterior 408.005	<b>Externa G</b> Exterior G 408.011	<b>Externa P</b> Exterior P 408.012	<b>Interna</b> Interior 408.013	<b>Externa</b> Exterior 408.015
<b>Externa P</b> Exterior P 408.021	<b>Interna</b> Interior 408.022	<b>Externa</b> Exterior 408.023	<b>Interna</b> Interior 408.024	<b>Tranca para Banheiro</b> For Bath/Para Baños 408.004   408.006		<b>Tranca para Banheiro</b> For Bath/Para Baños 408.014   408.016	

## Entradas Rosetas / Rosette Options

<b>Externa G</b> Exterior G 001	<b>Externa P</b> Exterior P 002	<b>Interna</b> Interior 003	<b>Externa</b> Exterior 005	<b>Tranca para Banheiro</b> For Bath/Para Baños 004   006
<b>Externa G</b> Exterior G 011	<b>Externa P</b> Exterior P 012	<b>Interna</b> Interior 013	<b>Externa</b> Exterior 015	<b>Tranca para Banheiro</b> For Bath/Para Baños 014   016

## Roseta Rosette

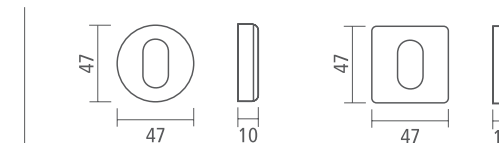

## Roseta Milla Milla Rosette

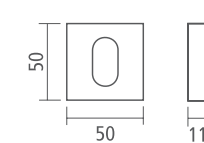

## Tranqueta Thumb Turn Spindle Snib Muletilla Condena y Descondena

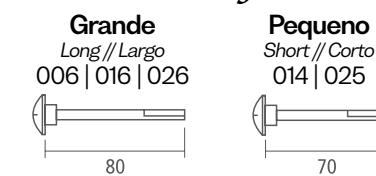

## Entradas Espelhos / Plates Options

<b>Externo P</b> Exterior P 021	<b>Interno</b> Interior 022	<b>Externo</b> Exterior 023	<b>Interno</b> Interior 024	<b>Tranca Banheiro</b> For Bath/Para Baños 025	<b>Tranca Banheiro</b> For Bath/Para Baños 026	<b>Espelhos</b> Plates
<b>Externo P</b> Exterior P 021	<b>Interno</b> Interior 022	<b>Externo</b> Exterior 023	<b>Interno</b> Interior 024	<b>Tranca Banheiro</b> For Bath/Para Baños 025	<b>Tranca Banheiro</b> For Bath/Para Baños 026	<b>Espelhos</b> Plates



OBISPA.

## **ACABAMENTOS**

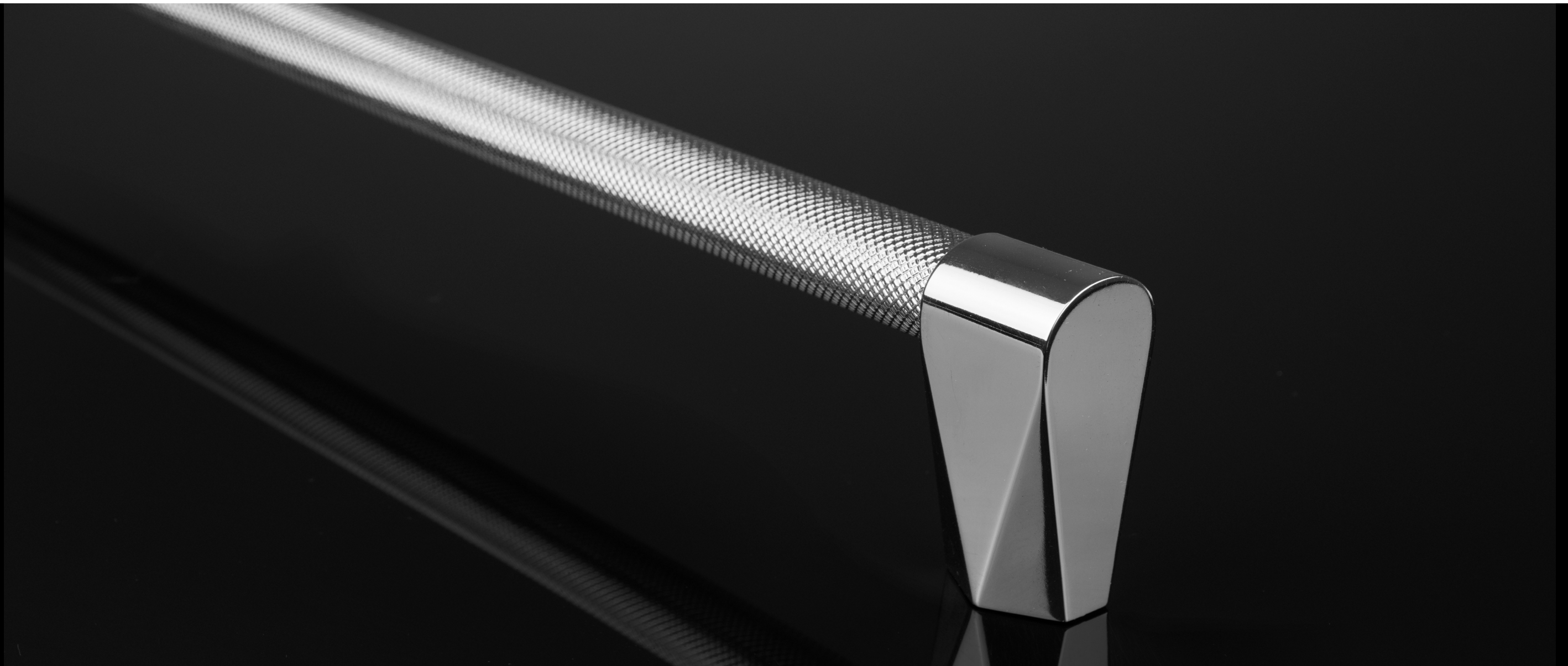

### Pinturas Elements

*Elements Painted*

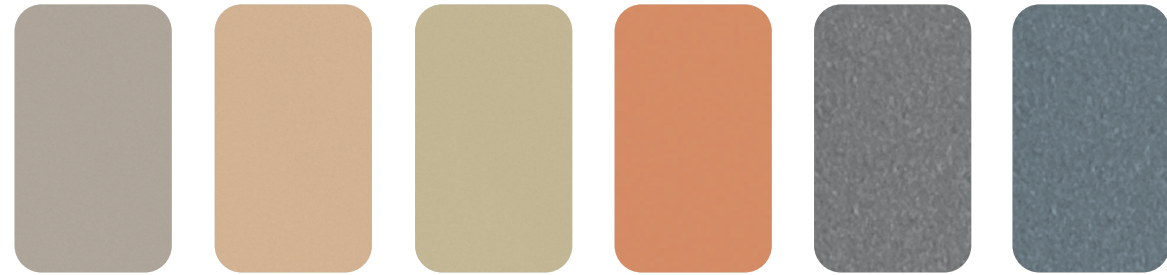

Sole /410

Rosé /407

Oro /406

Terra Vermelha /408

Ágata Negra /411

Titânio /413



Marsala /412

### Pinturas Galaxy

*Galaxy Painted*

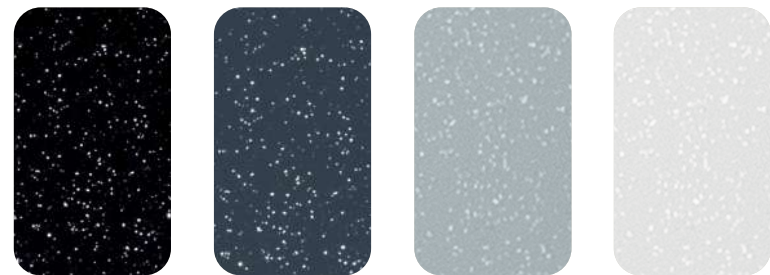

Night 402

Evening /405

Moon /404

Light 403

### Pinturas

*Painted*

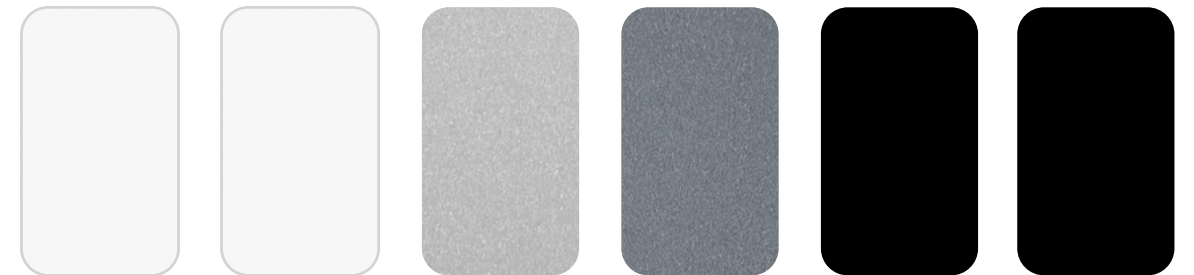

Branco /222

Bianco Opaco /322

Alumínio /205

Grafite /290

Preto /210

Nero Opaco /324



Marrom /211



Champagne /206

### Couros

*Leather / Cueros*

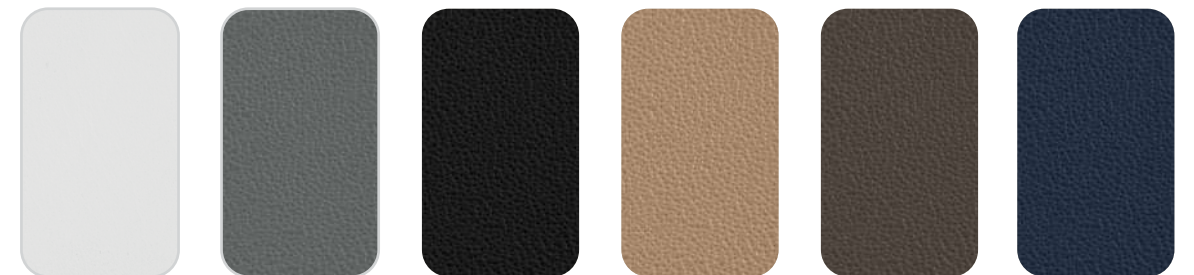

Branco / B

Cinza / CC

Preto / P

Areia / A

Café / C

Azul-marinho / AM



## Banho Galvânico

*Coated / Galvanicos*



Cromo /188    Cromo Escov. /189    Níquel /83    Níquel Escov. /79    Níquel Negro /60    Níquel Velho /15



Black Silk /102    Ouro /262    Ouro Escovado /147    Dorato /348    Dorato Esc. /365    Latão Velho /21

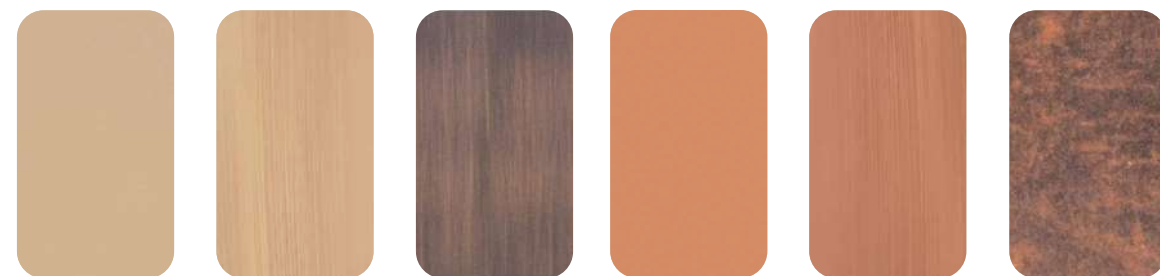

Ouro Rosa /143    Ouro Rosa Esc. /315    Cobre Velho /363    Cobre /378    Cobre Esc. /379    Cobre Antique /334



Mármore /333

## Banho Galvânico Opaco

*Matte Coated / Galvanicos Mate*



Black Silk Opaco/360    Níquel Velho Opaco/120    Níquel Opaco /112    Cobre Opaco /337    Cobre Velho Opaco/356    Cobre Antique Opaco/338



Ouro Rosa Opaco/372    Ouro Opaco /357    Latão Velho Opaco/359    Mármore Opaco/358    Preto Opaco /435

As tonalidades são próximas aos acabamentos reais.

Os acabamentos cobre opaco, cobre antique, cobre antique opaco, cobre velho opaco, mármore, mármore opaco, ouro opaco, black silk opaco e latão velho opaco terão variações entre um produto e outro, pois possuem processos manuais.

Colors serve as reference and are close to reality.

Color tones for matte copper, antique matte, antique matte cooper, matte old cooper, marble, matte marble, matte gold, matte black silk and matte old brass and have slight variation since some processes are handcraft.

Los colores sirven para referencia y son próximos a realidad.

Los acabados cobre mate, cobre antique, cobre antique mate, cobre viejo mate, mármol, mármol mate, oro mate, black silk mate y laton viejo mate pueden tener una pequeña variación en el ton por tener procesos manuales.

### Pietra Liso

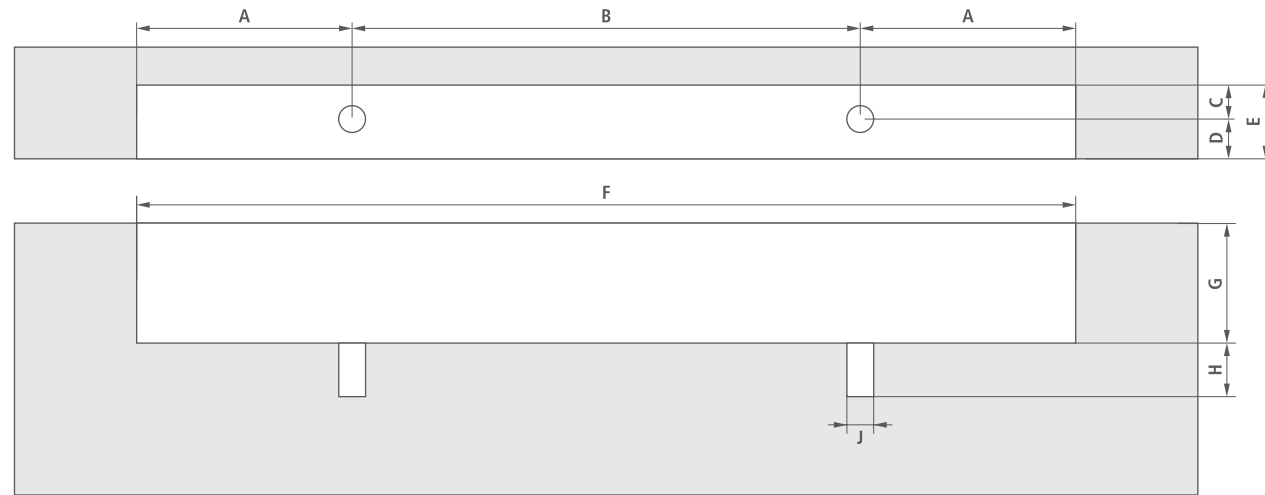

Ref	A	B	C	D	E	F	G	H	I
100.779	48,5	128	7	9	16	225	27	12	6

### Ghost

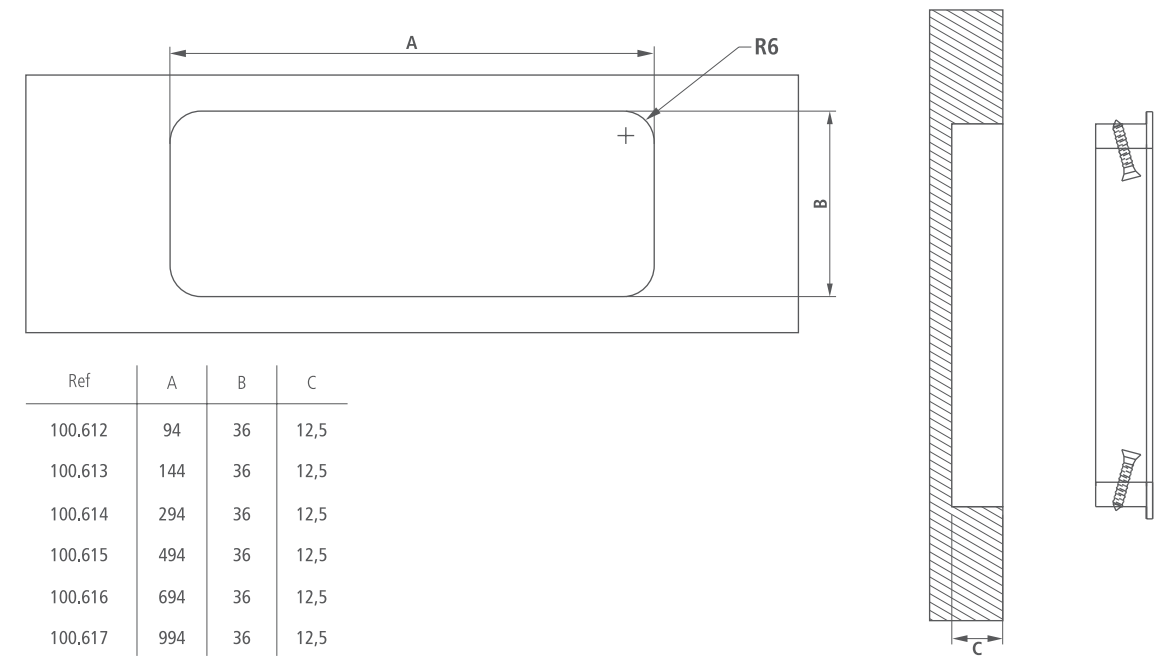

Ref	A	B	C
100.612	94	36	12,5
100.613	144	36	12,5
100.614	294	36	12,5
100.615	494	36	12,5
100.616	694	36	12,5
100.617	994	36	12,5

### Interface

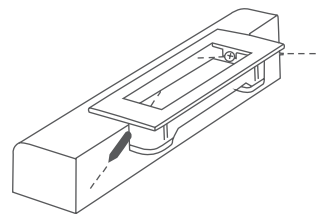
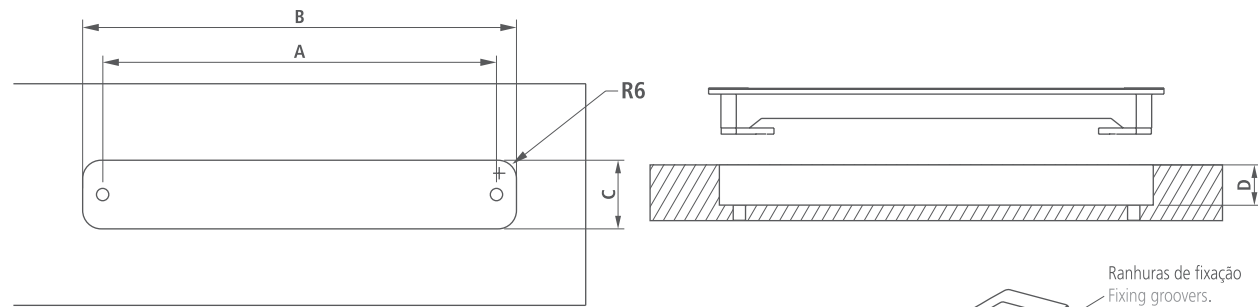

Aplicação na madeira com parafuso.  
Wood use with screws.  
Uso en madera con tornillos.

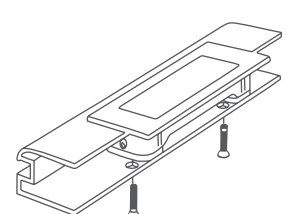

Aplicação no perfil com parafuso.  
Profile use with screws.  
Uso en perfiles con tornillos.

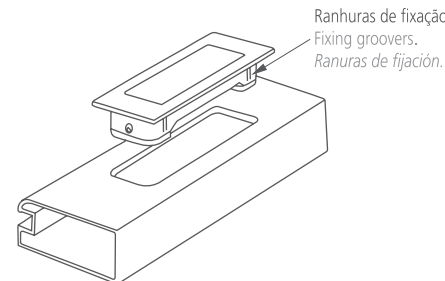

Aplicação no perfil sob pressão.  
Profile use without screws.  
Uso en perfiles sin tornillos.

Ranhur de fixação  
Fixing groovers.  
Ranuras de fijación.

Ref	A	B	C	D
100.460	128	141	22	13
100.552	-	268	42	15

### Moldue e Moldue Couro

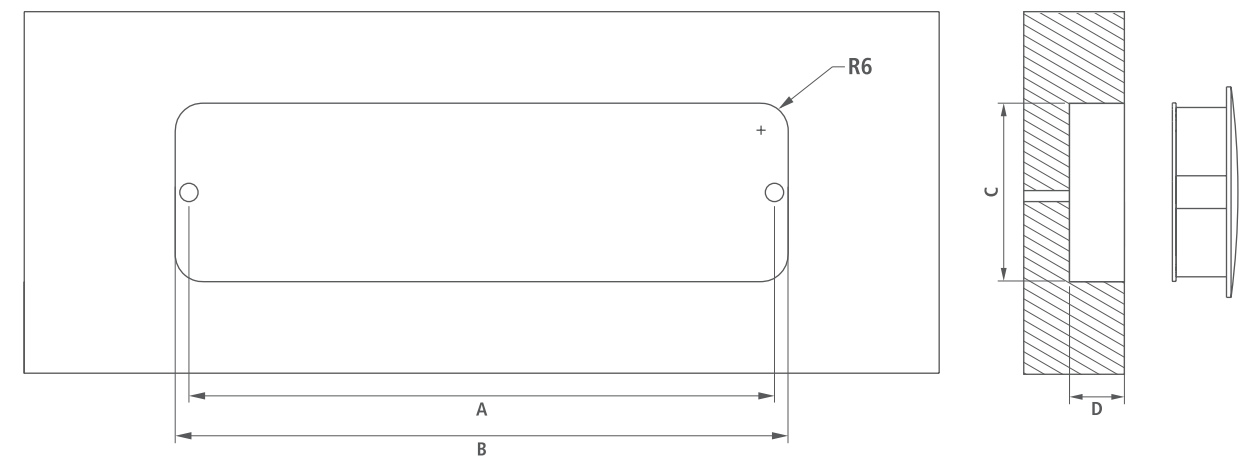

Ref	A	B	C	D
100.488	128	135	37	12
100.489	192	198	37	12
100.621	320	328	43	13

Ref	A	B	C	D
100.644	128	135	37	12
100.645	192	198	37	12
100.646	320	328	43	13

**Dimensões:**  
largura x comprimento x profundidade.  
width x length x depth.  
acho x largo x profundidad.  
CC: center-to-center // entre centros

**Dimensões:**  
largura x comprimento x profundidade.  
width x length x depth.  
acho x largo x profundidad.  
CC: center-to-center // entre centros



# Occhi

Espessura mínima de 15 mm. // Minimun thickness of 15 mm. // Espesura mínima de 15 mm.

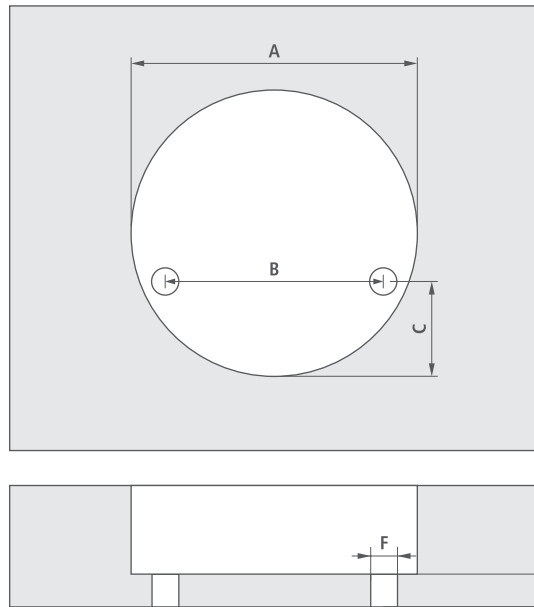

Ref	A	B	C	D	E	F
100.745	42	32	14	12	passante	5

# Box e Ring

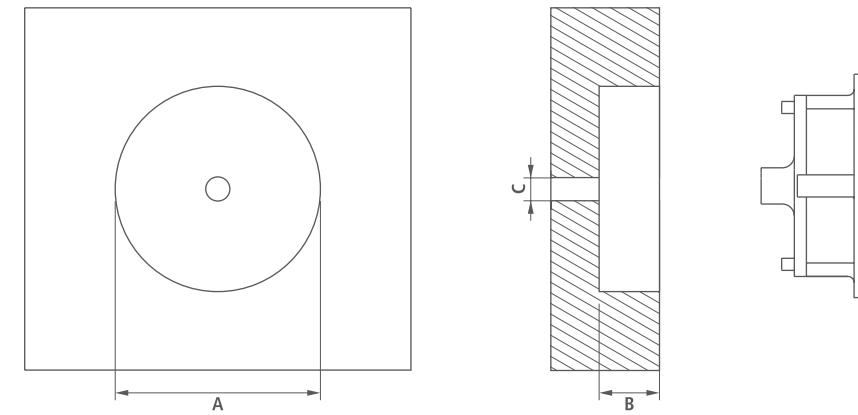

Ref	A	B	C
100.620	34	10	6.5
100.447	34	10	6.5

# Retrô Metal

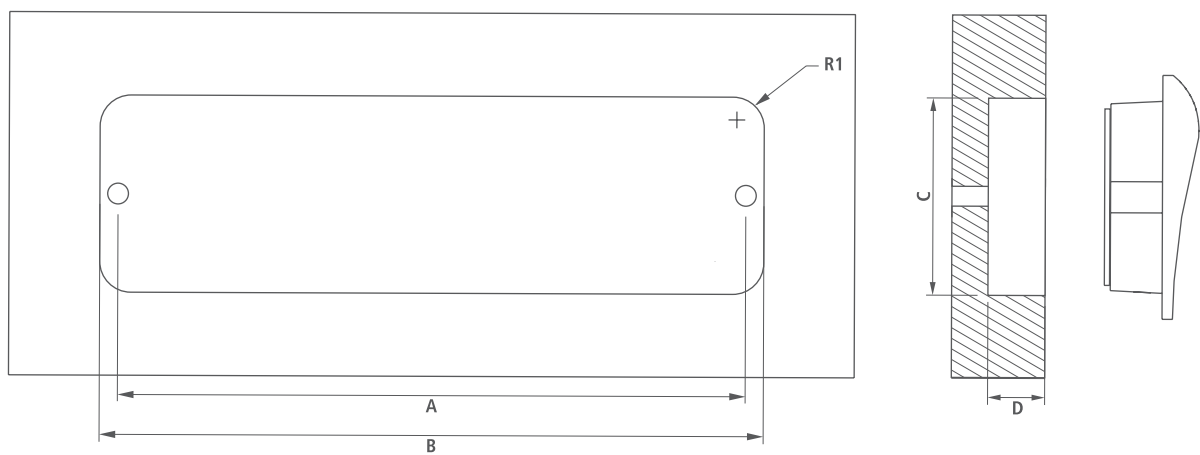

Ref	A	B	C	D
100.267	48	55	37	12
100.268	128	135	37	12

# Boticelli

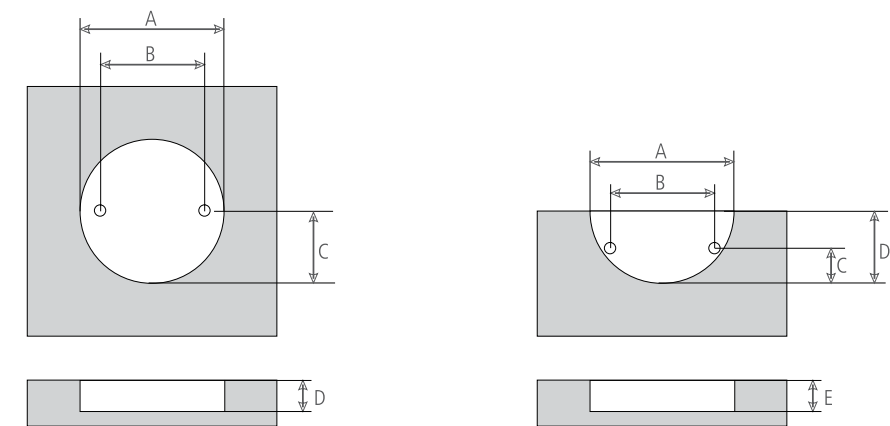

Ref	A	B	C	D
151.083	50	44	25	13
151.084	50	44	25	13
151.085	50	44	25	13
151.089	75	69	37.5	13
151.090	75	69	37.5	13
151.091	75	69	37.5	13

Ref	A	B	C	D	E
151.086	50	32	9.9	24	13
151.087	50	32	9.9	24	13
151.088	50	32	9.9	24	13
151.092	75	55	16.7	35.5	13
151.093	75	55	16.7	35.5	13
151.094	75	55	16.7	35.5	13

**Dimensões:**  
largura x comprimento x profundidade.  
width x length x depth.  
acho x largo x profundidad.  
CC: center-to-center // entre centros

**Dimensões:**  
largura x comprimento x profundidade.  
width x length x depth.  
acho x largo x profundidad.  
CC: center-to-center // entre centros



## DICAS DE CONSERVAÇÃO

Não utilize álcool, detergente ou solventes na limpeza dos metais, pois eles retiram a camada de verniz aplicada nos produtos;

Esponja de aço ou outros materiais abrasivos devem ser evitados. Prefira apenas um pano macio seco, ou levemente umedecido em água;

Após algum tempo de uso, as peças podem sofrer acomodamento, sendo necessário reajustar sua fixação;

A Obispa não se responsabiliza por possíveis danos decorrentes de desgaste natural, conservação inadequada ou mau uso dos produtos.

### MADE GOOD USE OF YOUR PRODUCT

*Do not use alcohol, detergent or solvents in cleaning metals, as they remove the layer of varnish applied to the products;*

*Sponge steel or other abrasive materials should be avoided. Prefer only a soft, dry cloth or slightly moistener with water;*

*After some time of use the parts can suffer an adjustment. Then, it is necessary to readjust its fixation;*

*Obispa shall not be liable for any damages arising from the natural wear and tear, improper conservation or bad use of products.*

### COMO MANTENER SU PRODUCTO

*No utilice alcohol, detergente o disolvente de limpieza de metales, que eliminan la capa de barniz aplicada a los productos;*

*Deben evitarse las esponjas de acero u otros materiales abrasivos. Preferir un paño suave seco o ligeramente humedecido con agua;*

*Después de un tiempo de uso las piezas pueden sufrir la complacencia. Por lo tanto, es necesario volver a ajustar la configuración;*

*Obispa no se responsabiliza de posibles daños resultantes de desgaste natural, mantenimiento o uso indebido y inadecuada de los productos.*



WWW.OBISPADESIGN.COM.BR

**OBISPA.**



@obispadesign

Rua Joana Guindani Tonello, 2021  
Bento Gonçalves • RS • Brasil  
+55 54 2102.6000

---